

KESON[®]

MAKE YOUR MARK[®]

Product Catalog

Volume 26



KESON[®]

MAKE YOUR MARK[®]

Our grandfather and Keson's founder, Roy Nosek, often said, if a job is worth doing, it's worth doing right.

We know he didn't say it first, but he said it first to our fathers who said it first to us. He showed us what it means through the way he lived his life and the way he treated people.

- Be Positive
- Work Hard
- Respect Others
- Have Fun
- Act Ethically
- Do Good



MAKE YOUR MARK.

We believe in these principles. We strive to practice them in all that we do.

Keson products are for people who are passionate about their work and getting it done right.

Handwritten signature of Aaron Nosek.

Aaron Nosek
President

Handwritten signature of Jude Nosek.

Jude Nosek
Marketing

Handwritten signature of Dave Nosek.

Dave Nosek
Human Resources

TABLE OF CONTENTS

4 PRODUCT HIGHLIGHTS

6 MEASURING

7 MEASURING WHEELS

- 8 Summary
- 10 Metal
- 13 Plastic
- 17 Paint Applicators

18 LEVELS

- 20 Overview
- 22 Box Beam
- 23 Box Beam Magnetic
- 24 Digital
- 25 I-Beam
- 26 Screed
- 27 Short

28 LONG TAPE MEASURES

- 28 Open Case Steel Blade
- 32 Closed Case Steel Blade
- 33 Open Case Fiberglass Blade
- 37 Open Case Fiberglass Blade

38 SHORT TAPE MEASURES

- 38 Summary
- 40 Professional Series
- 41 Toggle Series
- 42 Ultra Bright Series
- 43 Wide Blade Series
- 44 Automatic Lock Series
- 45 Magnetic & Economy Series

46 SPECIALTY MEASURES

- 47 Pocket Tapes
- 47 Keychain Tape
- 48 Diameter Tapes
- 48 Pocket Rods
- 49 Wood Rulers
- 51 Surveyor's Ropes
- 51 Depth Gauges

52 MARKING

53 CHALK LINE REELS

- 55 Precision
- 56 Standard
- 57 Bold
- 58 Giant

59 CHALK

63 TWINE

64 PAINT

65 SPECIALTY MARKING

- 65 Valve Paint
- 65 Lumber Crayons
- 65 Pencils
- 65 Pens

66 FLAGGING AND BARRICADE TAPE

- 66 Barricade & Flagging Tape
- 67 Stake Flags
- 67 Detectable Tape

68 BLADE MEASURES

73 INDEX

KESON LEVELS FEATURING SOLA PATENTED TECHNOLOGY!

KESON is thrilled to be partnered with SOLA. Our line of levels all feature Austrian-made SOLA vials, the most accurate in the world. The majority of our levels feature the FOCUS Vial, which offers a 20% magnification to ensure an accurate reading.



LKB | Box Beam



LKBM | Magnetic Box Beam



LKBD | Digital Box Beam
(Also Available in Magnetic)



LKI | I-Beam



LKS | Screed Level



LKTFM | Magnetic Aluminum Torpedo Level



LKTALRM | Plastic Aluminum Magnetic Level



LKTSP | Plastic Squared Level



LKTRF | Plastic Rounded Level



LKTprm | Small Plastic Level



LKGOM | GO! Magnetic



LKL3 | Line Level

PROFESSIONAL SERIES



Professional Series tape measures offer a nylon coated blade in a high-impact, high-visibility housing. Full rubber grip for a comfortable and slip-resistant hold.

- High-visibility ABS housing with full rubber grip
- Nylon coated steel blade
- 3-rivet end hook (2-rivet on lengths up to 12 ft.)

WOOD RULERS



Keson offers 6-foot wood folding rules for a variety of uses.

- WR1818X rule with 6-inch brass extender
- WR1818 rule has inside read markings
- WR1810 rule provides an Engineer's scale
- WR18M rule is the 2-meter metric version
- WR18BL rule offers a brick mason's scale

CHALK LINE REELS



K3XPRO

K3X

K3XPRO Features:

- BigMouth chalk port for easy fill up
- Metal handle
- 3X rewind with clutch release
- ABS/Aluminum housing
- 100-foot PRECISION string line

K3X Features:

- BigMouth chalk port for easy fill up
- Metal handle
- 3X rewind with clutch release
- ABS housing
- 100-foot STANDARD string line

MEASURING

MEASURING
WHEELS

LEVELS

LONG TAPE
MEASURES

SHORT TAPE
MEASURES

SPECIALTY



BEST VALUE AND BIGGEST VARIETY



We work hard to make sure our measuring wheels are the best in the world. We are the new standard, leading the industry in the development of wheels with better features and more valuable benefits.

- Our counters are the sturdiest and the most reliable. Our wheels are designed to protect the counter, the most valuable component of the wheel.
- With the industry's strongest frames, the MP wheels have become the professional's choice.
- Longest Warranties—Limited Lifetime Warranty on all but 3 models (2-year limited wheel warranty for MP401E and RRT series).
- Safety—All of our large wheels come with a reflector to help keep you safe while you work.

ACCURACY

99.7% accurate on a flat, even track.



Some components sourced globally.

All of our wheels (except the RRT series) are molded, assembled, and tested in Aurora, IL.

VARIETY

MP SERIES Metal Professional Series of high-end durable wheels. We even have Steel Frame Electronic and Decimeter wheels, the only ones of their kind.

RRT SERIES Handle brake and reset on the most versatile wheel series in our offering.

RR KESONITE SERIES Metal/Resin compound wheels with the durability and shape memory of molded composite and the weight of metal.

RR SERIES LARGE AND SMALL Original RoadRunner Series of contractor grade, more economically-priced wheels.

PAINT APPLICATORS Measure and mark simultaneously with our inverted spray paint applicators.

*Units of Measure offered: English, 10ths and Metric.

DESIGN

We listen. We create new products and improve current models based on your feedback and our own expertise. We're continuously improving our products and processes to provide better service.

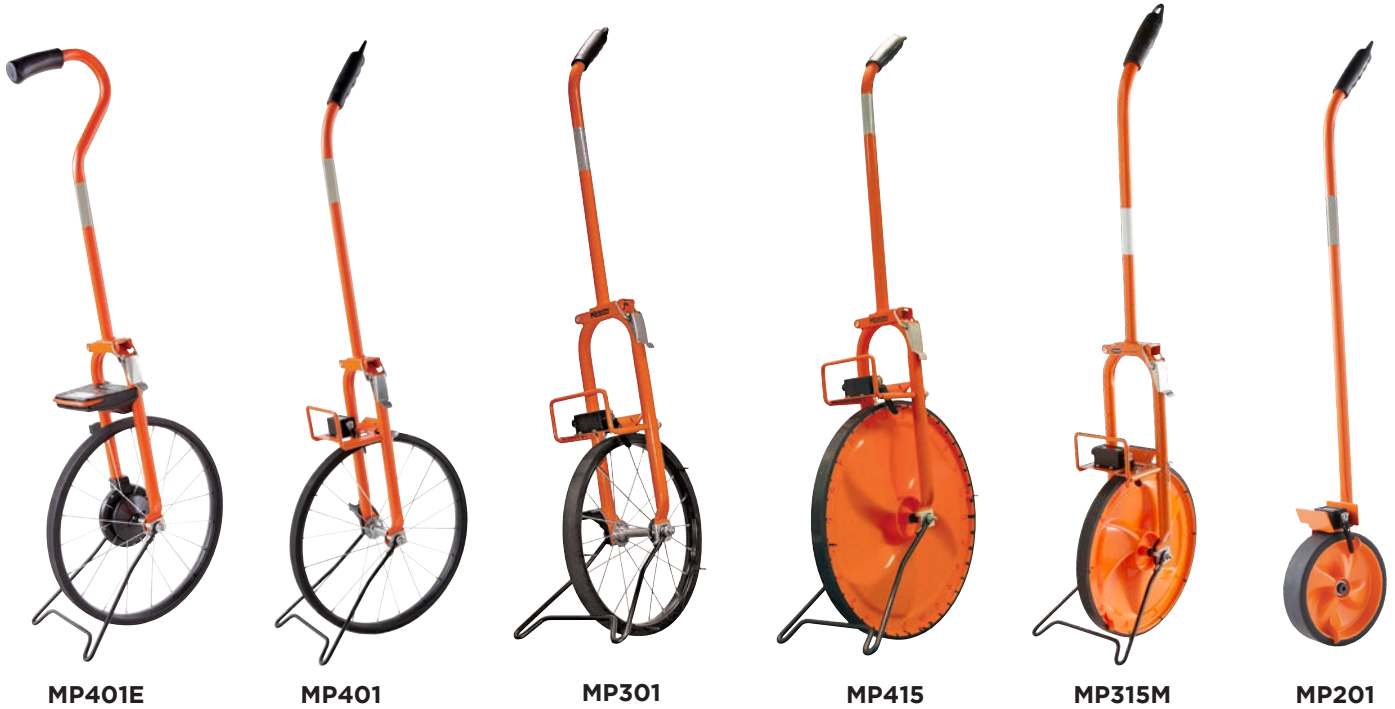

METAL PROFESSIONAL WHEELS

These Metal Professional (MP) wheels are durable enough to stand up to the harshest field conditions. All feature a rugged steel frame with the industry's best counters with the best counter protection.

FEATURES

- Innovative design—simple, center-line functionality. Great balance.
- Huge numbers make for easy reading. Superior protection and placement of the counter—the metal shelf keeps dirt and debris from coming into contact with the counter (5 digits, up to 99,999).
- Rugged 3/4 inch steel frame—tough enough to handle any terrain.
- Compact fold-down—easily folds in half for storage and portability.



Some components sourced globally.

MODEL	UPC 052837	UNITS	DIA.	CIRC.	SPECIAL
MP401E	026715	ft., in & ft, 10ths, metric, continous in.	15-1/2 in.	4 ft.	Digital Counter: Multiple units of measure, adds radius, memory, and more.
MP401	025756	ft.	15-1/2 in.	4 ft.	Best seller
MP415	026449	ft. & in. & 10ths	15-1/2 in.	4 ft	Solid plastic wheel, dual scale
MP401P	026111	ft.	15-1/2 in.	4 ft	Plastic spoked wheel
MP301	026128	ft.	11-1/2 in.	3 ft	Best seller
MP315M	027040	m & dm	.318 m	1 m	Solid wheel, metric
MP301M	025763	m	.318 m	1 m	Steel spoked, metric wheel
MP301DM	026265	m & dm	.318 m	1 m	Steel, decimeter
MP201	008315	ft.	7-1/2 in.	2 ft.	Solid molded wheel

Limited lifetime warranty / MP401E: 2-year limited warranty.

PLASTIC WHEEL MODEL SUMMARY



PLASTIC MEASURING WHEELS

Innovative wheels make measuring quick and easy. Balanced and lightweight, and extremely durable.

MODEL	UPC 052837	UNITS	DIA.	CIRC.	SPECIAL	WARRANTY
RRT6	027422	ft. & in.	6 in.	18 in.	Handle trigger reset and brake	2 Yr. Limited
RRT610	027576	ft. & 10ths	6 in.	18 in.		
RRT6M	027569	m, dm	15.2 cm	45.7 cm		
RRT12	027415	ft. & in.	12 in.	3 ft.	Handle trigger reset and brake	2 Yr. Limited
RRT1210	027460	ft. & 10ths	12 in.	3 ft.		
RRT12M	027477	m, dm	.318 m	1 m		
RR30	026425	ft., in.	11-1/2 in.	3 ft.	Metal/Resin wheel provides increased strength and weight	Limited Lifetime
RR3010	026524	ft., 10ths	11-1/2 in.	3 ft.		
RR30M	026500	m, dm	.318 m	1 m		
RR40	026463	ft., in.	15-1/2 in.	4 ft.	Best seller	Limited Lifetime
RR318N	008506	ft., in.	12-1/2 in.	3 ft.		
RR318N-2	008506	ft., in.	12-1/2 in.	3 ft.	No assembly (2 per box)	Limited Lifetime
RR310	010172	ft., 10ths	12-1/2 in.	3 ft.		
RR3M	010189	m, dm	.318 m	1 m		
RR418	010196	ft., in.	15-1/2 in.	4 ft.	Great for rough terrain	Limited Lifetime
RR410	010202	ft., 10ths	15-1/2 in.	4 ft.	Great for rough terrain	
RR112	020058	ft., in.	4 in.	1 ft.	Best seller	Limited Lifetime
RR110	020065	ft., 10ths	4 in.	1 ft.		Limited Lifetime
RR10M	020072	m, dm	.097 m	.305 m		
RR182	010592	ft., in.	4 in.	1 ft.	Dual-wheel stability	Limited Lifetime
RR102	010608	ft., 10ths	4 in.	1 ft.	Dual-wheel stability	
RRPA18	022298	ft. & in.	4 in.	1 ft.	Single wheel & applicator	Limited Lifetime
RRPA182	020768	ft. & in.	4 in.	1 ft.	Dual wheel & applicator	

MP401E

MP-ELECTRONIC | 1 SKU

WORLD'S STRONGEST ELECTRONIC MEASURING WHEEL

The MP401E is the only electronic wheel with a steel frame. It is the world's sturdiest electronic measuring wheel and the easiest and most comfortable to use. It will stand up to the harshest conditions.

Our easy-to-read digital counter is in the most protected spot on the wheel. With the handle up, it is nearly impossible for the counter to come into contact with the ground. With the handle down, the roll bar offers solid protection. Counter requires 2 AA batteries (not included).



50% OF ACTUAL SIZE

Backlit 7 Digit LCD display for low-light usage. Up to 99,999 feet, 11 inches or 99,999.9 in tenths and metric.

FEATURES

- Swan-Neck Ergonomic Handle.** Our patent-pending "thumb-up" grip ensures less wrist strain and superior control.
- Reliable Input System: Magnetic Sensors.** Dust, dirt and other particles can disrupt a light beam used in competitive units. Our magnetic pick-up avoids these problems.
- Sealed Counter Encasement.** Designed to NEMA Class III standards, our counter housing ensures that it will not be damaged by rain. What's more, you can safely clean the entire wheel with a damp cloth.



Some components sourced globally.



MPLGCASE



MP401E

MODEL	UPC 052837	UNITS	DIA.	CIRC.	SPECIAL
MP401E	026715	ft., in. & ft., 10ths, m, dm, continous in.	15-1/2 in.	4 ft.	Digital Counter: Multiple units of measure, adds radius, memory, and more.
MPLGCASE	026876				Nylon carrying case

2-year limited warranty.

MP SERIES

MP-SPOKED | 5 SKUs, 3 SIZES

METAL PROFESSIONAL SPOKED WHEELS



ACTUAL SIZE

Our geared mechanical clicker counter features large, bold 3/4-inch numbers

FEATURES

MP401

Our best selling metal wheel. The 4-foot circumference wheel levels out uneven ground by spanning divets that smaller wheels would dip in to. The wheel's size enables it to roll and register feet clicks at the best pace in the industry.

MP301

Not far behind the MP401 in popularity, this slightly more compact wheel is a little lower in price without compromising any durability.

MP301M

Our 1 meter circumference wheel registers a single meter click per revolution. It's about the same size as the MP301.

MP301DM

This is an industry first — we have 10 evenly spaced pins around the 1 meter circumference of this wheel. The result is a metal wheel that registers in decimeters.

MP401P

We mold 4-foot wheels for our RR series and for a less expensive alternative to the spoked wheels, we offer this model.



MP401

MPLGCASE

MODEL	UPC 052837	UNITS	DIA.	CIRC.	SPECIAL
MP301	026128	ft.	11-1/2 in.	3 ft.	Best seller
MP301M	025763	m	.318 m	1 m	Steel metric wheel
MP301DM	026265	m, dm	.318 m	1 m	Most accurate decimeter wheel
MP401	025756	ft.	15-1/2 in.	4 ft.	Best seller
MP401P	026111	ft.	15-1/2 in.	4 ft.	Plastic wheel, metal frame
MPLGCASE	026876				Nylon carrying case

Limited lifetime warranty.

Measuring Wheels

Levels

Long Tapes

Short Tapes

Specialty Measures

Chalk & Chalk Line Reels

Specialty Marking

MP SERIES

MP-SOLID | 3 SKUs, 3 SIZES

METAL PROFESSIONAL SOLID WHEELS

There are advantages to solid wheels. A sliding tool box or a shovel in the back of a truck has destroyed the precision of many a spoked wheel. Solid plastic wheels are not nearly as susceptible to these impacts. Also, solid Keson wheels do not go “out of round.” You cannot bend them or flatten a portion of them. Lastly, twigs, sticks, tall grasses, and other brush do not get caught up in the spokes or lock these wheels up. If your job takes you through fields or trails, consider a solid wheel option.



Our geared Mechanical Clicker Counter features easy-to-read numbers.

FEATURES

1. **No Spokes** to catch grass or sticks and won't bend or snap.
2. **Solid Molded Wheels** do not bend or go “out of round”.

MP415

The counter measures feet and there are two scales molded into the hub of the wheel itself: inches on one side and 10ths on the other.

MP315M

On our metric version, decimeter graduations are molded into the hub of the wheel.

MP201

Strong, rigid, 1-piece steel handle—strongest in the industry. Without a collapsing point in the handle, there is no weak point on this frame. This solid wheel is two inches wide, giving it better traction on sand, loose gravel and wet ground; a favorite among landscapers.

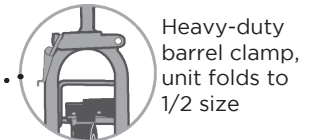
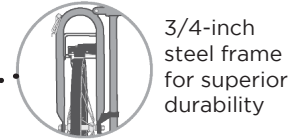

MODEL	UPC 052837	UNITS	DIA.	CIRC.	SPECIAL
MP201	008315	ft.	7-1/2 in.	2 ft.	Solid molded wheel
MP315M	027040	m, dm	.318 m	1 m	Solid, metric
MP415	026449	ft., in & ft., 10ths	15-1/2 in.	4 ft.	Solid, two scales wheel
MPLGCASE	026876				Nylon carrying case
MPSMCASE	026883				Nylon carrying case for MP201

Limited lifetime warranty.

RRT SERIES

RRT-BASIC | 6 SKUs, 4 SIZES

RRT6 / RRT12

The RRT Series focuses on control and comfort. Resetting has never been easier with two options, a reset on the handle AND on the unit housing. The center-line handle design makes this unit well balanced. Our compact fold-down uses a collapsing hinge and handle lock to reduce the unit to half its original size.

5-Digit, Easy read counter measures 9,999 feet, 11 inches (9,999.9 ft. on the engineers' models and 9,999.9 meters on metric).



FEATURES

- Enhanced Grip Pistol-type Handle** increases control and comfort.
- Brake on Pistol Grip** stops counting instantly. Stop adding lengths accidentally by putting the brake on exactly when you need it.
- Gear and Shaft Transmission** for highest measurement accuracy and strength. No belts to stretch or fail.
- Reset on the Handle and Unit Housing** no more bending over, lifting the wheel or stepping on it to reset to zero. Additionally, the reset on the housing is reinforced to protect it when resetting the counter with your foot.
- Quick Release Hinge**



MODEL	UPC 052837	UNITS	DIA.	CIRC.	SPECIAL
RRT6	027422	ft. & in.	6 in.	18 in.	Handle trigger reset and brake
RRT610	027576	ft. & 10ths	6 in.	18 in.	
RRT6M	027569	m, dm	15.2 cm	45.7 cm	
RRT12	027415	ft. & in.	12 in.	3 ft.	Handle trigger reset and brake
RRT1210	027460	ft. & 10ths	12 in.	3 ft.	
RRT12M	027477	m, dm	.318 m	1 m	
RRT6BAG	028214				Nylon carrying case for the smaller RRT wheels
RRT12BAG	028207				Nylon carrying case for the larger RRT wheels

2-year limited warranty.

Measuring Wheels

Levels

Long Tapes

Short Tapes

Specialty Measures

Chalk & Chalk Line Reels

Specialty Marking

ROADRUNNER SERIES

RR-KESONITE™ | 4 SKUs, 3 SIZES

KESONITE™ WHEEL SERIES

There are inherent vulnerabilities of die cast and metal spoked wheels. Everyday use requires that a wheel handle some rough treatment without dents and without bending.

Not all wheels are up to this. Our solution? Invent a new material. Kesonite is a strong, dense metal/resin composite. It holds its shape better than metal and it's stronger than a spoked or die cast wheel. The weight of the wheel makes it easier to use and more accurate on rough terrain.

Based on the design of the RR Series Large, a model with over 20 years of continuous improvement, including wheel design, material, and safety reflector!

FEATURES

1. **Pistol Grip Handle** increases control and comfort.
2. **Quick Snap Cam** locks to store and transport the wheel with minimal effort.
3. **Telescopes** down to 23 inches cam locks make the unit simple to operate when preparing for storage or transportation.
4. **Flip-Down Kickstand** keeps the wheel upright when you need your hands free to perform other tasks and stays out of the way as you measure.
5. **Safety Reflector**
6. **Metal/Resin Composite** wheel offers the weight and strength of a die-cast wheel with more durability.



Some components sourced globally.



Easy-to-read, Magnified Counter

5-digit, easy-read, magnified counter measures 9,999 feet, 11 inches (9,999.9 ft on engineers' model and 9,999.9 meters on metric)

MODEL	UPC 052837	UNITS	DIA.	CIRC.	SPECIAL
RR30	026425	ft., in.	11-1/2 in.	3 ft.	Metal/Resin wheel provides increased strength and weight.
RR3010	026524	ft., 10ths	11-1/2 in.	3 ft.	
RR30M	026500	m, dm	.318 m	1 m	
RR40	026463	ft., in.	15-1/2 in.	4 ft.	

Limited lifetime warranty.

ROADRUNNER SERIES

RR-CONTRACTOR | 6 SKUs, 3 SIZES

CONTRACTOR GRADE

With over 20 years of continuous improvements, the RR Series Contractor Grade measuring wheels are the most popular in our offering.

The reset on the unit housing is reinforced to protect the unit when using feet. Heavy-duty polycast wheel has clean three-spoke design.

FEATURES

1. **Pistol Grip Handle** increases control and comfort.
2. **Quick Snap Cam** locks to store and transport the wheel with minimal effort.
3. **Telescopes** down to 23 inches cam locks make the unit simple to operate when preparing for storage or transportation.
4. **Flip-Down Kickstand** keeps the wheel upright when you need your hands free to perform other tasks and stays out of the way as you measure.
5. **Safety Reflector**



Some components sourced globally.



Easy-to-read, Magnified Counter

5-digit, easy-read, magnified counter measures 9,999 feet, 11 inches (9,999.9 ft on engineers' model and 9,999.9 meters on metric)



RR318N

MODEL	UPC 052837	UNITS	DIA.	CIRC.	SPECIAL
RR318N	008506	ft., in.	12-1/2 in.	3 ft.	Best seller
RR318N-2	008506	ft., in.	12-1/2 in.	3 ft.	No assembly (2 per box)
RR310	010172	ft., 10ths	12-1/2 in.	3 ft.	
RR3M	010189	m, dm	.318 m	1 m	
RR418	010196	ft., in.	15-1/2 in.	4 ft.	Great for rough terrain
RR410	010202	ft., 10ths	15-1/2 in.	4 ft.	

Limited lifetime warranty.

Measuring Wheels

Levels

Long Tapes

Short Tapes

Specialty Measures

Chalk & Chalk Line Reels

Specialty Marking

ROADRUNNER SERIES

RR-INDOOR | 5 SKUs, 2 SIZES

INDOOR/SHORT RUN WHEELS

Smaller 1-foot wheels combine Keson quality and reliability with convenient size and lightweight. Typically used in short run and indoor applications these products are compact and very reliable. It's easy to measure curved, horizontal, and asymmetrical surfaces.

These products are popular with realtors, appraisers, police officers, and homeowners. You can measure alone, and you can measure faster than two people with a tape measure.

FEATURES—SINGLE WHEEL

1. Weighs less than 2 pounds.
2. Telescopes down to 17 Inches fits into a toolbox or briefcase.
3. 38 inches tall when fully extended.

FEATURES—DUAL WHEEL

1. Reset with foot a raised reset button that enables you to reset the counter with your foot. Improved reset supporting structure can handle foot taps to zero the counter.
2. Greater stability when measuring, making it easier to maintain a straight line as you walk.
3. Telescopes down to 20 Inches fits into a toolbox or briefcase.
4. 42 inches tall when fully extended.



Easy-to-read, Magnified Counter

5-digit, easy-read, magnified counter measures 9,999 feet, 11 inches (9,999.9 ft on engineers' model and 9,999.9 meters on metric)



RR112
Single Wheel

RR182
Dual Wheel

MODEL	UPC 052837	UNITS	DIAMETER	CIRC.	SPECIAL
RR112	020058	ft., in.	4 in.	1 ft.	Dual-wheel stability
RR110	020065	ft., 10ths	4 in.	1 ft.	
RR10M	020072	m, dm	.097 m	.305 m	
RR182	010592	ft., in.	4 in.	1 ft.	
RR102	010608	ft., 10ths	4 in.	1 ft.	

Limited lifetime warranty.

PAINT APPLICATORS

MEASURE AND MARK

Measure and mark simultaneously with RRPA18 and RRPA182. These lightweight tools feature a trigger just under the pistol grip. Engaging the trigger fires off a burst of upside-down spray paint precisely where it's needed.

FEATURES

1. **Pistol Grip and Trigger** to spray paint exactly where you want it.
2. **Paint Can Sleeve** fits all standard US-style inverted aerosol paint cans.
3. **Reset with Foot** when using the RRPA18 or RRPA182.
4. **Handheld Applicator**
5. **PA35** comes with an optional, attachable wheel, and metal shaft.

RRPA18 & RRPA182



Some components sourced globally.



Easy-to-read, Magnified Counter The single wheel and dual wheel both have a 5-digit, easy-read, magnified counter that measures 9,999 feet, 11 inches without resetting. That's almost two miles.



MODEL	UPC 052837	UNITS	CIRC.	SPECIAL
RRPA18	022298	ft. & in.	12 in.	Single wheel with applicator
RRPA182	020768	ft. & in.	12 in.	Dual wheel with applicator
PA14	010066			Handheld applicator
PA35	010059			Metal shaft and optional wheel

Limited lifetime warranty.

Measuring Wheels

Levels

Long Tapes

Short Tapes

Specialty Measures

Chalk & Chalk Line Reels

Specialty Marking

ACCURACY AND PRECISION TO GET IT DONE RIGHT

Keson levels are among the best performing levels in the market. We are very excited to utilize SOLA's long history of manufacturing excellence and cutting-edge innovation to provide an affordable version of high quality levels under the Keson brand. All Keson levels are made in either Austria or Hungary.

Keson Box Beam, Screed Torpedo Levels contain SOLA FOCUS vials.

WWW.SOLA.US



THE FOCUS VIAL

Simply put, the vial is the heart of the level. Keson's box beam levels all come with FOCUS vials. These vials incorporate the superior contrast of all SOLA FOCUS vials, and have 20% greater magnification than a typical ring vial.

VIAL FEATURES

- 20% magnification for easier reading
- No split bubble in case of shock or static
- Greater contrast compared to traditional ring vials
- Luminous strip for low light situations
- Break-resistant acrylic block vial with Limited Lifetime Warranty
- Greater contrast & 20% magnification
- Superior fluid
- Anti-static
- Extreme temperature ranges
- Anti-shock action
- Luminous strip

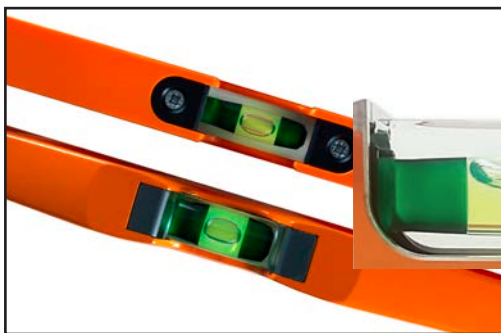

SOLA vials in full light



SOLA vials in low light

PROFILES

A level's profile impacts the overall quality of the level. Higher quality levels have a heavier, robust profile. How the vials are held in place is also critically important. In general, there are two types of profiles for general construction levels: Box Beam and I-Beam.

BOX BEAM LEVELS

Strongest profiles, best vials. Box Beam levels are the best levels for general construction. They combine high accuracy, acrylic vials, durability, and ease of use. Box Beam levels are higher quality, and significantly more durable than I-Beam levels.

I-BEAM LEVELS

Good general purpose, light use levels that need to be checked more regularly for accuracy. I-Beam levels are less durable by design. If treated carefully these levels can provide a long life; however, they do not have the robustness of Box Beam levels.



Box Beam Profile

SCREEDING LEVELS

A specialty level that is designed for landscaping and concrete work. Our special H-beam design provides superior strength. They can also be used as a check rod. Built with the vial included in the tool, our screed level provides an extremely high degree of accuracy and consistency.

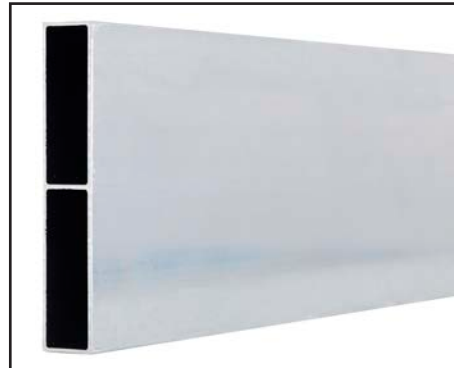

Screed Profile



I-Beam Profile

PROFESSIONAL LEVELS FEATURING SOLA FOCUS VIALS

KESON is thrilled to be partnered with SOLA Measuring Tools. The Keson box beam levels are made in Austria with the FOCUS-20 vial, offering 20% magnification and high accuracy of $\leq 0.0.29''$ in standard position.

Multiple styles and lengths are available, with options sure to perform well in every situation.



LKB | Box Beam



LKBM | Magnetic Box Beam



LKBD | Digital Box Beam
(Also Available in Magnetic)



LKI | I-Beam



LKS | Screed Level

NOTE: All levels are made in Austria except * are made in Hungary.



LKTFM*
Magnetic Aluminum Torpedo Level



LKTSF
Plastic Squared Level



LKTRF
Plastic Rounded Level



LKTALRM
Plastic Aluminum Magnetic Level



LKTPRM
Small Plastic Magnetic Level



LKGOM | GO! Magnetic



LKL3 | Line Level

NOTE: All levels are made in Austria except * are made in Hungary.

Measuring Wheels

Levels

Long Tapes

Short Tapes

Specialty Measures

Chalk & Chalk Line Reels

Specialty Marking

BOX BEAM SERIES

LKB SERIES | 7 SKUs, 6 LENGTHS

STRONG PROFILES, BEST VIALS

Keson Box Beam levels are among the best levels available in North America.

FOCUS VIAL
by SOLA
⊕+20%



**LKB SERIES
BOX BEAM LEVEL**

Strong profiles, SOLA FOCUS-20 vials, high accuracy

FEATURES

1. **Heavy Profile Weight** for durability
2. **Two Material End Caps** for extra protection against damage
3. **Milled Measuring Surface**
4. **FOCUS 20 SOLA Vial** with 20% magnification for easier reading
5. **Luminous Vial** for improved readability in low light situations
6. **Cushioned Hand Holds**

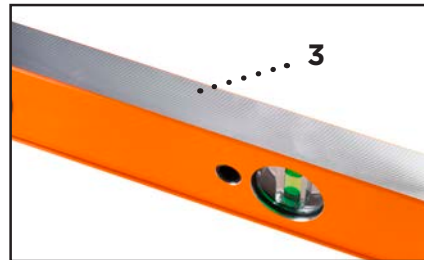
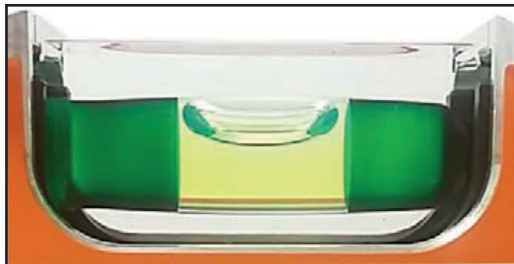

≤0.0005 in./in. /
≤0.5 mm/m / ≤0.029°



≤0.00075 in./in. /
≤0.75 mm/m / ≤0.043°



860 G/M STRENGTH
860 G/M de Fuerza / Force

MODEL	UPC 052837	LENGTH	# VIALS	SPECIAL
LKB24	028818	24 in.	3	No hand holds
LKB32	028825	32 in.	3	2 hand holds
LKB48	028832	48 in.	3	
LKB72	028849	72 in.	3	
LKB78	028856	78 in.	3	
LKB96	028863	96 in.	3	
LKB7832	028870	32 in. & 78 in.	3 each	Jamb set with hand holds

BOX BEAM MAGNETIC SERIES

LKBM SERIES | 6 SKUs, 5 LENGTHS

FOCUS VIAL
by SOLA
Ø +20%







LKBM SERIES MAGNETIC BOX BEAM LEVEL

Strong profiles, SOLA FOCUS-20 vials, high accuracy, laterally installed magnets

FEATURES

1. **Heavy Profile Weight** for durability
2. **Two Material End Caps** for extra protection against damage
3. **FOCUS 20 SOLA Vial** with 20% magnification and luminous backing for easier reading
4. **Cushioned Hand Holds**
5. **Lateral Magnet Installation** for a clean measuring surface



-  $\leq 0.0005 \text{ in./in.} / \leq 0.5 \text{ mm/m} / \leq 0.029^\circ$
-  $\leq 0.00075 \text{ in./in.} / \leq 0.75 \text{ mm/m} / \leq 0.043^\circ$
-  **860 G/M STRENGTH**
860 G/M de Fuerza / Force
-  **MAGNETIC**
Magnético / Magnétique

MODEL	UPC 052837	LENGTH	# VIALS	SPECIAL
LKB24M	028962	24 in.	3	Lateral Magnets
LKB32M*	028979	32 in.	3	
LKB48M	028986	48 in.	3	Lateral Magnets 2 hand holds
LKB72M	028993	72 in.	3	
LKB78M*	029006	78 in.	3	
LKB7832M*	029013	32 in. & 78 in.	3 each	Jamb set

* While supplies last

Measuring Wheels

Levels

Long Tapes

Short Tapes

Specialty Measures

Chalk & Chalk Line Reels

Specialty Marking

DIGITAL LEVEL SERIES

LKBD SERIES | 2 SKUs, 2 LENGTHS

All the features and benefits of the standard box beam levels with digital read-out. Our Digital version is great for confirming ADA compliance, and comes with:

- Measuring tolerance module:
 - > 0.05° at 0° and 90°
 - > 0.1° between 1° and 89°
- Adjustable inclination display in °, %, mm/m and in/ft.
- “Hold” function for storing measured values and for transferring angles.
- Audible signal guidance available in difficult visible conditions.
- Easy to see with reversible display for inverted measurements.
- Protection class IP65 keeps the electronics safe from the environment.

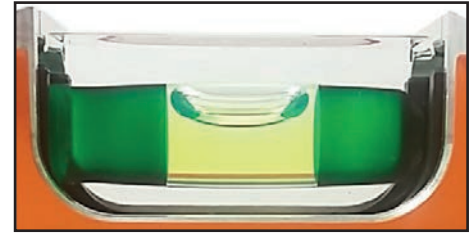

ACTUAL SIZE

- ≤0.0005 in./in. / ≤0.5 mm/m / ≤0.029°
- ≤0.00075 in./in. / ≤0.75 mm/m / ≤0.043°
- 860 G/M STRENGTH**
860 G/M de Fuerza / Force

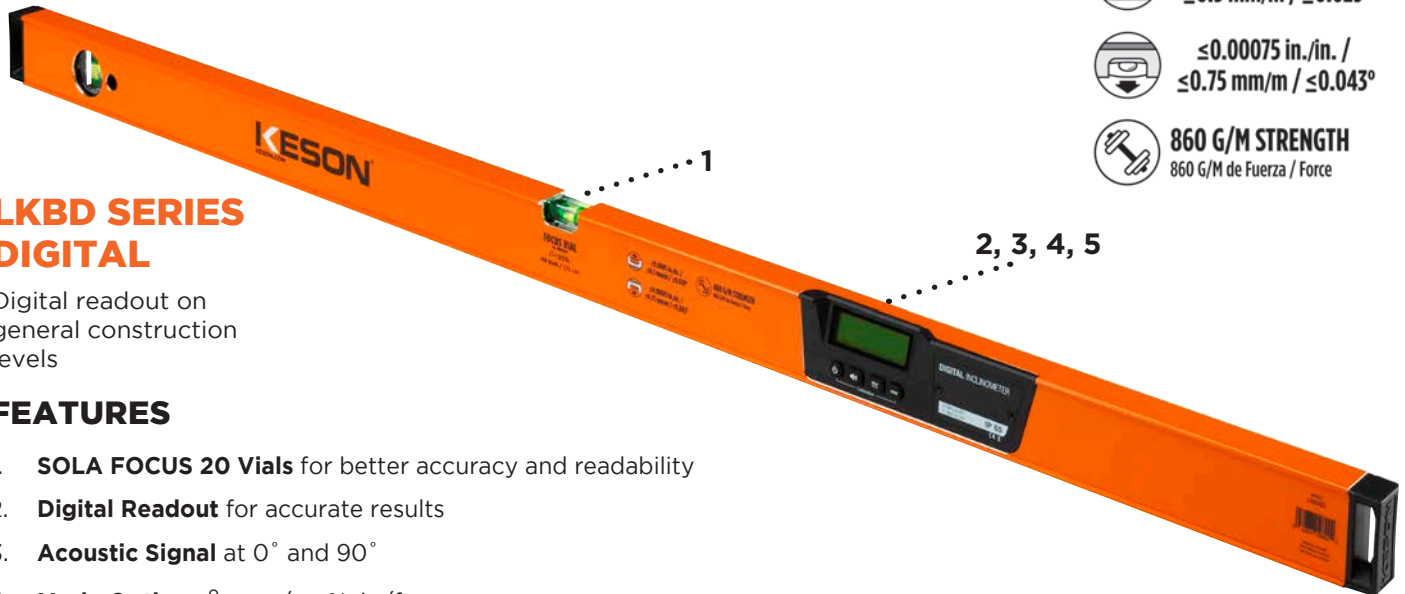

LKBD SERIES DIGITAL

Digital readout on general construction levels

FEATURES

1. **SOLA FOCUS 20 Vials** for better accuracy and readability
2. **Digital Readout** for accurate results
3. **Acoustic Signal** at 0° and 90°
4. **Mode Options** °, mm/m, %, in/ft.
5. **Display Options:** ABS (absolute) and INC (incremental)



MODEL	UPC 052837	LENGTH	# VIALS	SPECIAL
LKB24D	028917	24 in.	2	Digital Readout
LKB48D	028924	48 in.	2	

I-BEAM SERIES

LKI SERIES | 3 SKUs, 3 LENGTHS

General purpose levels for construction. I-Beam levels are designed to be a lightweight option to a box beam level, while still providing durability and accuracy.

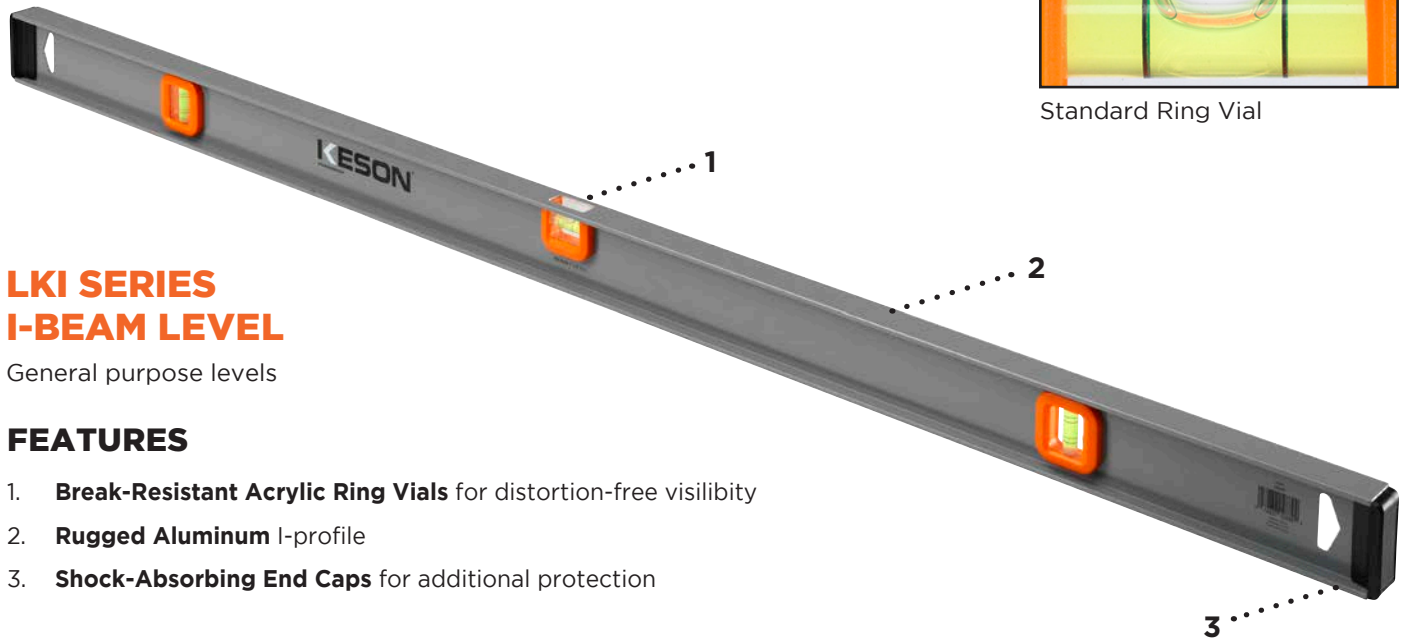

LKI SERIES I-BEAM LEVEL

General purpose levels

FEATURES

1. **Break-Resistant Acrylic Ring Vials** for distortion-free visibility
2. **Rugged Aluminum I-profile**
3. **Shock-Absorbing End Caps** for additional protection



I-Beam Profile
without end cap

MODEL	UPC 052837	LENGTH	# VIALS	SPECIAL
LKI24	028887	24 in.	3	Light weight
LKI48	028894	48 in.	3	
LKI72	028900	72 in.	3	

Measuring Wheels

Levels

Long Tapes

Short Tapes

Specialty Measures

Chalk & Chalk Line Reels

Specialty Marking

SCREEDING SERIES

A specialty level that is the best level for landscaping and concrete work. Our special H-beam design provides superior strength. They can also be used as a check rod to ensure the flatness of whatever surface you're working on. The vial is built directly into the tool, providing a degree of accuracy and consistency not achievable with levels clipped onto screeds. No adjustments needed for clipped or screwed on vials.

Keson Aluminum Screeding levels are designed for use in leveling cement, sand or paving stones in driveways, sidewalks and patios. This level has a high wall construction. Keson Screed levels are made to the most exacting European specifications. Will withstand rugged daily use and temperature changes. Easy to read Focus vial is made of shockproof acrylic for durability. Made in Austria.

LKS SERIES

Ideal for landscape and concrete screeding

FEATURES

1. **SOLA FOCUS 20 Vials** for better accuracy and readability
2. **End Caps** are shock absorbing, allowing the level to withstand use and abuse
3. **Wide handles** for use outside of the screeding area.
4. **Rugged 6063 aluminum alloy frame** provides the highest accuracy for perfect measuring results

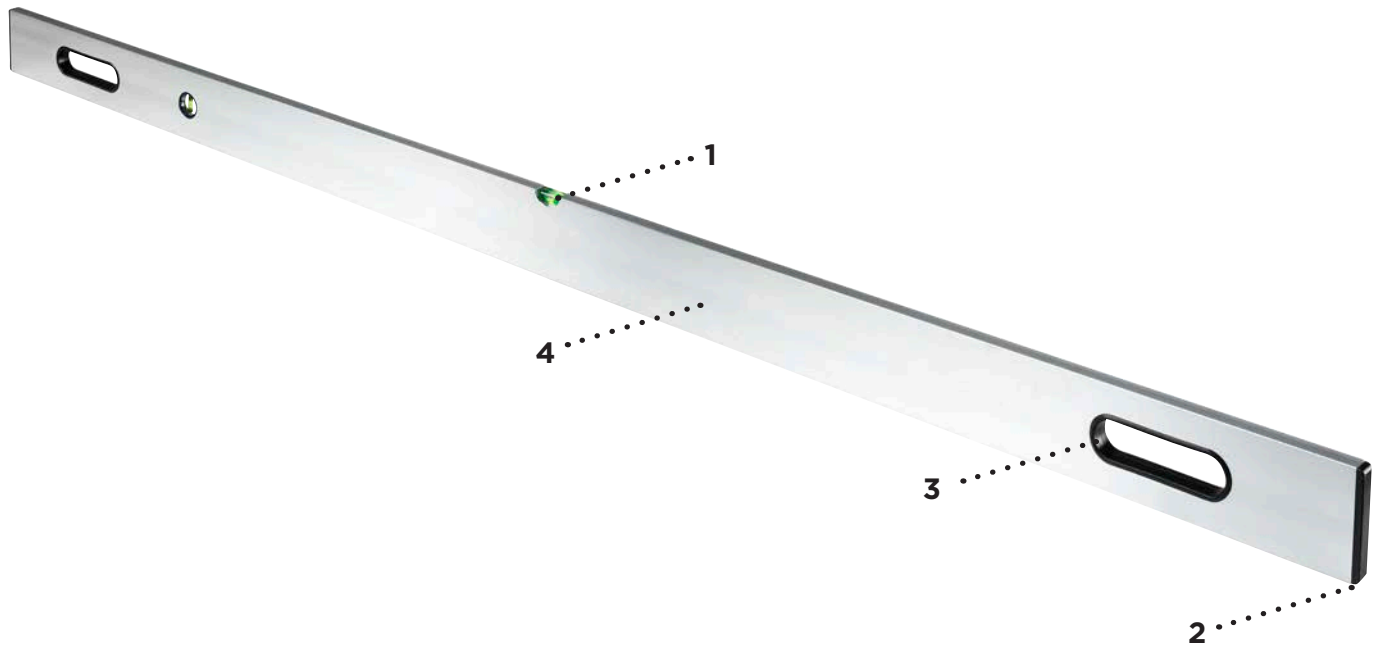

LKS SERIES | 6 SKUs, 5 LENGTHS

FOCUS VIAL
by SOLA
⊕ +20%

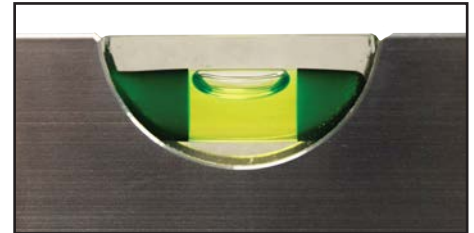

ACTUAL SIZE

MODEL	UPC 052837	LENGTH	# VIALS	SPECIAL
LKS39	029075	39 inches	2	No hand holds
LKS59	029082	59 inches	2	
LKS78A	029167	78 inches	2	Hand holes centered for easy 1-person application
LKS78	029099	78 inches	2	2 hand holes
LKS98	029105	98 inches	2	
LKS118	029112	118 inches	2	
LKS7839	029129	39 in. & 78 in.	2 each	

SHORT LEVELS

SHORT LEVELS | 7 SKUs

FOCUS VIAL
by SOLA
⊕ +20%



LKTFM
10" Die-Cast Torpedo with V-Groove

MAGNETIC ≤ 0.0005 in./in. ≤ 0.00075 in/in



LKGOM
GO! Magnetic Pocket Level

MAGNETIC ≤ 0.00075 in./in.

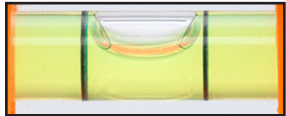

Standard Ring Vial



LKTRF
8.5" Plastic Torpedo, Rounded Edge

≤ 0.001 in/in



LKTSF
10" Plastic Torpedo with V-Groove

≤ 0.001 in/in



LKTALRM
9" Aluminum/Plastic Torpedo, Magnetic

MAGNETIC



LKL3
3" Line Level



LKTPRM
8" Plastic Torpedo, Magnetic

MAGNETIC ≤ 0.015 in./in.

MODEL	UPC 052837	VIAL	SPECIAL
LKTFM	029037	FOCUS-60	Die Cast. Extremely sturdy aluminum die-cast spirit level with a milled measuring surface and V-groove for scaffolding and steel pipes. FOCUS-60 vial for better, faster, and more accurate reading. .
LKGOM	029044	FOCUS-20	GO! A magnetic, portable level with belt clip. Perfect for quick checks and spot-on accuracy. V-groove for steel pipes.
LKTRF	028931	FOCUS-20	Round Edge. A rounded edge on one side of this torpedo enables a builder to get flush against walls that have a bevel in the corner. We have yet to find it's equal.
LKTSF	028948	FOCUS-20	Straight Edge. The classic torpedo with a FOCUS-20 vial.
LKTPRM	029051	Standard Ring	Straight Edge. This is a no frills, magnetic torpedo.
LKL3	028955	Standard Ring	Line Level. Our 3-inch line level is perfect for keeping your wall, fence or grading level when attached to a taut string line.
LKTALRM	029273	Standard Ring	Robust aluminum frame combined with ABS plastic guarantees long service life with low weight. Magnetic. *Also available as a counter display.

Display packages available

Measuring Wheels

Levels

Long Tapes

Short Tapes

Specialty Measures

Chalk & Chalk Line Reels

Specialty Marking

OPEN CASE STEEL BLADE TAPES



DOUBLE NYLON-COATED STEEL LONG TAPES

Since 1968, Keson steel tapes have met the highest standards of accuracy for surveyor quality measurements. They resist breakage and damage under the toughest field conditions. We understand that these tapes are critical to your profession. That's something we take very seriously, which is why we supply the best possible tapes we can.

Keson nylon-coated steel tapes are constructed with a double layered .2mm nylon, permanently bonded over a center core of 13mm steel. Our multi-layer construction assures corrosion resistance (even to salt water) and provides at least three times the usual tape life.

We have designed a variety of housing types for our customers: Stainless Steel (SNR), 3X High-Speed Rewind (NRS) and standard 1X rewind (NR). Double riveted or screwed cases, metal reinforced handles and shovel-style, rubber grips are standard on all of our offerings.

3/8-inch wide blades are about 10-20% lighter than 1/2-inch wide blades, without sacrificing durability. The thinner blades are also less likely to drift if the wind kicks up.

Keson offers the widest product selection of double nylon-coated blades. Units, attachments and zero points vary because of the precise needs of our many customers.

ZERO POINTS Where do the numbers start?

▼ Hook End, most common



▼ Tape End, typical with ring attachment



▼ Dead Foot—on the tape about 1-ft. from ring end

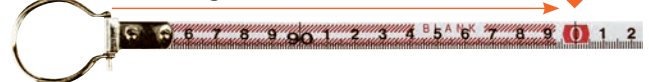

SILVER CRANK HANDLES = STEEL BLADES
BLACK CRANK HANDLES = FIBERGLASS BLADES

SNR SERIES

SNR SERIES | 10 SKUs, 4 LENGTHS

STAINLESS STEEL HOUSING, NYLON-REINFORCED STEEL BLADE

The world's best steel long tape in a housing that's built to last! The strongest housing (stainless steel!) on the market. There is no better housing available for our double nylon-coated steel blade. Both case and blades are built to ensure a long life under field abuse. Our rubber-grip shovel handle offers a comfortable, secure grip. The crank arm is metal as well.

FEATURES

1. **Rubber-Grip Shovel Handle** for comfortable, rapid reeling.
2. **Metal Crank Handle** for durability.
3. **Tough, Double Nylon-Coated Steel Blade** assures long life under field abuse.
4. **Housing Reinforced with Rivets** for superior strength.
5. **Strongest Housing on the Market!**



MODEL	UPC 052837	LENGTH	UNITS	ZERO POINT	ATTACHMENT	BLADE*
SNR18100	025985	100 ft.	ft, in, 1/8	Hook End	Hook	E1
SNR10100	026050	100 ft.	ft, 1/10, 1/100	Tape End + 1 ft	Ring	E19
SNR10100H	026197	100 ft.	ft, 1/10, 1/100	Hook End	Hook	E22
SNR18200	025992	200 ft.	ft, in, 1/8	Hook End	Hook	E1
SNR10200	026067	200 ft.	ft, 1/10, 1/100	Tape End + 1 ft	Ring	E19
SNR10200H	026258	200 ft.	ft, 1/10, 1/100	Hook End	Hook	E22
SNR18300	003501	300 ft.	ft, in, 1/8	Hook End	Hook	E1
SNR10300	003600	300 ft.	ft, 1/10, 1/100	Tape End + 1 ft	Ring	E19
SNR10300H	003624	300 ft.	ft, 1/10, 1/100	Hook End	Hook	E22
SNR100M	003808	100m	m, cm, mm	Tape End + .3m	Ring	E17

See Page 68.

Limited lifetime warranty.

Measuring Wheels

Levels

Long Tapes

Short Tapes

Specialty Measures

Chalk & Chalk Line Reels

Specialty Marking

NRS SERIES

NRS SERIES | 9 SKUs, 5 LENGTHS

NYLON-REINFORCED STEEL BLADE, 3X HIGH-SPEED REWIND

3X rewind, high-visibility housing! This 3X rewind series has the strongest gearing available. With metal, planetary gears, you can bring your steel tape back swiftly. Even with the weight of 300 feet or 100 meters of steel laying on a rough surface, our gears and metal-reinforced crank handle enables you to overcome the tape's inertia with ease.

FEATURES

1. **Rubber-Grip Shovel Handle** for comfortable, rapid reeling.
2. **High-Visibility Orange Polycarbonate Case**
3. **Metal, Planetary Gearing** for super-fast rewind & no more stripped gears.
4. **Tough, Double Nylon-Coated Steel Blade** assures long life under field abuse.
5. **Metal Reinforced Handle** for superior strength.
6. **3X Rewind**



MODEL	UPC 052837	LENGTH	UNITS	ZERO POINT	ATTACHMENT	BLADE*
NRS18100	020980	100 ft.	ft, in, 1/8	Hook End	Hook	E1
NRS10100H	022687	100 ft.	ft, 1/10, 1/100	Hook End	Hook	E22
NRS18M100	028061	100 ft./30m	ft, in, 1/8 & m, cm, mm	Hook End	Double Hook	E1 & E15
NRS18200	021000	200 ft.	ft, in, 1/8	Hook End	Hook	E1
NRS10200H	022694	200 ft.	ft, 1/10, 1/100	Hook End	Hook	E22
NRS18M200	028078	200 ft./60m	ft, in, 1/8 & m, cm, mm	Hook End	Double Hook	E1 & E15
NRS18300	021017	300 ft.	ft, in, 1/8	Hook End	Hook	E1
NRS10300H	022700	300 ft.	ft, 1/10, 1/100	Hook End	Hook	E22
NRS18M330	028368	330 ft./100m	ft, in, 1/8 & m, cm, mm	Hook End	Double Hook	E1 & E15

See Page 68.

Limited lifetime warranty.

NR SERIES

NR SERIES | 9 SKUs, 5 LENGTHS

NYLON-REINFORCED STEEL BLADE, STANDARD REWIND

A Keson best seller! Since 1968 this style of Keson steel tape has been providing customers with accurate measurements. They are used in the harshest conditions in which people measure, and they stand up to the only test that matters: field performance.

FEATURES

1. **Double Screws** hold housing together in case of an accidental drop.
2. **Improved Plastic and Molding Shape** for increased durability and long life.
3. **Tough, Double Nylon-Coated, 3/8-Inch Steel Blade** assures long life under field abuse, with reduced weight and wind drift.
4. **Metal Reinforced Handle** for superior strength.
5. **Break-Resistant Polycarbonate Case**



Metal reinforced handle

Multi-layer steel blade

MODEL	UPC 052837	LENGTH	UNITS	ZERO POINT	ATTACHMENT	BLADE*
NR18100	001903	100 ft.	ft, in, 1/8	Hook End	Hook	E1
NR10100	002207	100 ft.	ft, 1/10, 1/100	Tape End + 1 ft	Ring	E19
NR10100H	002504	100 ft.	ft, 1/10, 1/100	Hook End	Hook	E22
NR18165	009916	165 ft.	ft, in, 1/8	Hook End	Hook	E1
NR18200	001927	200 ft.	ft, in, 1/8	Hook End	Hook	E1
NR10200	002221	200 ft.	ft, 1/10, 1/100	Tape End + 1 ft	Ring	E19
NR10200H	002528	200 ft.	ft, 1/10, 1/100	Hook End	Hook	E22
NR30MH	022740	30m	m, cm, mm	Hook End	Hook	E3
NR60M	002818	60m	m, cm, mm	Tape End + .3m	Ring	E17

See Page 68.

Limited lifetime warranty.

Measuring Wheels

Levels

Long Tapes

Short Tapes

Specialty Measures

Chalk & Chalk Line Reels

Specialty Marking

ST SERIES

Our standard Steel Tape (ST) series tapes come in the industry’s most durable metal housing. These long, steel tapes have a compact, closed, metal case that fits nicely in your hand. The flush-folding crank pops up for easy rewinding. The graduations are painted black on a durable, bright-yellow steel blade.

FEATURES

1. **Closed, Metal Housing** protects the tape
2. **Rewind Handle** folds flush
3. **Compact**, fits easily into briefcase or a pocket.

ST SERIES | 4 SKUs, 2 LENGTHS



ST10018

MODEL	UPC 052837	LENGTH	UNITS	ZERO POINT	ATTACHMENT	BLADE*
ST5018	010394	50 ft.	ft, in, 1/8	Hook End	Hook	G1
ST10018	010387	100 ft.	ft, in, 1/8	Hook End	Hook	G1
ST10010	010738	100 ft.	ft, 1/10, 1/100	Hook End	Hook	G2
ST10018M	027651	100 ft./30m	ft, in, 1/8 & m, cm, 2mm	Hook End	Double Hook	G1 & G3

See Page 68

Limited lifetime warranty.

ST_3X & ST_Y SERIES

**LACQUER COATED, STEEL BLADE,
3X HIGH-SPEED REWIND**

3X rewind, high-visibility housing! This Steel Tape (ST_3X and ST_Y) series is great for those who need a longer tape but like the blade protection that a closed house offers. The ST_Y versions come with a belt clip.

FEATURES

1. **High-Impact Resistant Case** with full-rubber non-slip grip
2. **Lacquer-Coated, 3/8-inch Steel Blade** for superior durability and rust resistance
3. **3X Gearing (3X Series)** for super-fast rewind and no more stripped gears. Y-ending series have 1:1 rewind.

ST_3X; ST_Y SERIES | 9 SKUs, 2 LENGTHS



ST18M1003X

MODEL	UPC 052837	LENGTH	UNITS	ZERO POINT	ATTACHMENT	BLADE*
ST18503X	027248	50 ft.	ft, in, 1/8	Hook End	Hook	G1
ST10503X	027385	50 ft.	ft, 1/10, 1/100	Hook End	Hook	G2
ST181003X	026531	100 ft.	ft, in, 1/8	Hook End	Hook	G1
ST101003X	027118	100 ft.	ft, 1/10, 1/100	Hook End	Hook	G2
ST18M503X	027644	50 ft./15m	ft, in, 1/8 & m, cm, 2mm	Hook End	Double Hook	G1 & G3
ST18M1003X	027620	100 ft./30m	ft, in, 1/8 & m, cm, 2mm	Hook End	Double Hook	G1 & G3
ST1850Y	023509	50 ft.	ft, in, 1/8	Hook End	Hook	G1
ST18100Y	023516	100 ft.	ft, in, 1/8	Hook End	Hook	G1
ST18M100Y	027637	100 ft./30m	ft, in, 1/8 & m, cm, 2mm	Hook End	Double Hook	G1 & G3

See Page 68

Limited lifetime warranty.



HEAVY-DUTY

FIBERGLASS LONG TAPES

Since 1968, Keson fiberglass tapes have met the highest standards of accuracy for quality measurements. They resist breakage and damage under the toughest field conditions. We understand that these tapes are critical to your profession. That’s something we take very seriously, and that is why we supply the best possible tapes we can. We cover each blade with two coats of PVC protected by double shield, one to bind the fiberglass strands and a second over the printed units, so the numbers don’t wear away.

BLADES

Keson fiberglass reinforced tapes are designed to withstand more wear and tear than any other type of fiberglass measuring tape. They contain 40,000 fiberglass strands for greater tensile strength and superior accuracy when tension is applied. Two coats of PVC protect the tapes from breaking, and a blade shield adds strength to the attachment (the point at which most fiberglass tapes break). These tapes have proven dielectric strength of 200,000 V/M to assure your safety from electrical hazards.



Orange Tips for increased strength.

FIBER COUNT & TAPE WEIGHT

The weight of a tape is a factor to consider if you do a great deal of measuring. With our heavy-duty fiberglass tapes, we pack the strongest possible fibers — and the greatest number — into the thinnest possible tapes to keep the weights down while keeping the blades strong.

ELONGATION

Fiberglass tapes elongate (stretch) when excessive pulling force is applied. Keson heavy-duty fiberglass always returns to its proper length after the pulling stops. The reason is our high fiberglass strand count. To keep your fiberglass measurements as accurate as possible, don’t pull too hard when making your measurements.

HOUSINGS

We have designed a variety of housing types for our customers: Freewheeling Long Tape (FLT), 3X High-Speed Rewind (OTRS) and Standard 1X Rewind (OTR). Double riveted or screwed cases, metal reinforced handles and shovel-style, rubber grips are standard on all of our offerings.

PRODUCT SELECTION

Keson offers the widest product selection of fiberglass blades. Units, attachments and zero points vary because of the precise needs of our many customers.

SILVER CRANK HANDLES = STEEL BLADES
BLACK CRANK HANDLES = FIBERGLASS BLADES

FLT SERIES

FLT SERIES | 8 SKUs, 3 LENGTHS

FREEWHEELING

3X rewind, high-visibility housing! Our patented freewheeling release enables you to disengage the gearing, paying out the blade without a whirling handle.

Count on Keson Fiberglass Tapes for the strength and accuracy you expect on your job. Easy-to-read permanently bonded graduations. Folding end hook. The cross-arm open reel has a folding rewind handle and a “stake point.” Designed to withstand more wear and tear than any other kind of measuring tape! Given the roughest treatment possible... trampled underfoot, dragged through mud, dust, or rock abrasion, Keson fiberglass tapes go on taking abuse with little or no deterioration.

FEATURES

1. **Ergonomically Designed Housing Handle** with tactile rubber grip for balance and comfort.
2. **Freewheeling Hub** for fast pay out of blade without spinning crank. No more busted knuckles! Re-engage with the push of a button.
3. **Locking Pawl** enables proper blade tension during measurement.
4. **Double PVC Coated Fiberglass Blade** is nonconducting, top-quality, and won't shrink or deteriorate.
5. **Massive Crank Arm** with large, easy-grip knob for comfort and reliability.
6. **Knob** folds down for storage



MODEL	UPC 052837	LENGTH	UNITS	ZERO POINT	ATTACHMENT	BLADE*
FLT18165	027170	165 ft.	ft, in, 1/8	Hook End	Hook	F1
FLT10165	027187	165 ft.	ft, 1/10, 1/100	Hook End	Hook	F2
FLT18M165	027163	165 ft./50m	ft, in, 1/8 & m, cm, 2mm	Hook End	Double Hook	F1 & F13
FLT18200	027156	200 ft.	ft, in, 1/8	Hook End	Hook	F1
FLT10200	027132	200 ft.	ft, 1/10, 1/100	Hook End	Hook	F2
FLT1810200	027316	200 ft.	ft, in, 1/8 & ft, 1/10, 1/100	Hook End	Double Hook	F1 & F14
FLT18M200	027149	200 ft./60m	ft, in, 1/8 & m, cm, 2mm	Hook End	Double Hook	F1 & F13
FLT50MM	027194	50m	m, cm, 5mm & m, cm, 2mm	Hook End	Hook	F12 & F13

See Page 69

Limited lifetime warranty.

OTRS SERIES

OTRS SERIES | 14 SKUs, 4 LENGTHS

3X HIGH-SPEED REWIND

3X rewind, high-visibility housing! Our best offering in a fiberglass housing. The OTRS series pairs an incredibly durable housing with our excellent blades. End caps on the arms further protect the housing. We cover each blade with two coats of PVC protected by double shield, one to bind the fiberglass strands and a second over the printed units, so the numbers don't wear away.

The 3X high-speed rewind gearing is made up of metal, strip-proof gearing.

FEATURES

1. **Rubber Shovel Handle** for a comfortable, "no-slip" grip.
2. **Metal, Strip-Proof Gearing**
3. **Double PVC Coated Fiberglass Blade** with additional tape end guard for ultimate tape protection.
4. **Metal Reinforced Crank Handle** lasts longer.
5. **End Caps** on the arms further protect the housing.



Metal reinforced handle

MODEL	UPC 052837	LENGTH	UNITS	ZERO POINT	ATTACHMENT	BLADE*
OTRS18100	027217	100 ft.	ft, in, 1/8	Hook End	Hook	F1
OTRS10100H	026746	100 ft.	ft, 1/10, 1/100	Hook End	Hook	F2
OTRS1810100	028085	100 ft.	ft, in, 1/8 & ft, 1/10, 1/100	Hook End	Double Hook	F1 & F14
OTRS1810100E	027675	100 ft.	ft, in, 1/8 & ft, 1/10, 1/100	Tape End	Ring	F20
OTRS18M100	028108	100 ft./30m	ft, in, 1/8 & m, cm, 2mm	Hook End	Double Hook	F1 & F13
OTRS18200	027224	200 ft.	ft, in, 1/8	Hook End	Hook	F1
OTRS10200H	026753	200 ft.	ft, 1/10, 1/100	Hook End	Hook	F2
OTRS1810200	028160	200 Ft.	ft, in, 1/8 & ft, 1/10, 1/100	Hook End	Double Hook	F1 & F14
OTRS1810200E	026005	200 ft.	ft, in, 1/8 & ft, 1/10, 1/100	Tape End	Ring	F20
OTRS18M200	028177	200 ft./60m	ft, in, 1/8 & m, cm, 2mm	Hook End	Double Hook	F1 & F13
OTRS18300	027231	300 ft.	ft, in, 1/8	Hook End	Hook	F1
OTRS10300H	026760	300 ft.	ft, 1/10, 1/100	Hook End	Hook	F2
OTRS1810300E	026012	300 ft.	ft, in, 1/8 & ft, 1/10, 1/100	Tape End	Ring	F20
OTRS1810330	028092	330 ft.	ft, in, 1/8 & ft, 1/10, 1/100	Hook End	Double Hook	F1 & F14

See Page 69

Measuring Wheels

Levels

Long Tapes

Short Tapes

Specialty Measures

Chalk & Chalk Line Reels

Specialty Marking

OTR SERIES

OTR SERIES | 30 SKUs, 9 LENGTHS

OPEN-TYPE REEL, ULTRA-GLASS BLADE, STANDARD

A Keson best seller! Since 1968 this style of Keson fiberglass tape has been providing customers with accurate measurements. They are used in the harshest conditions in which people measure, and they stand to the only test that matters: field performance. We cover each blade with two coats of PVC protected by double shield, one to bind the fiberglass strands and a second over the printed units, so the numbers don't wear away.

FEATURES

1. **Tough, Molded Shovel Handle** is easy to grasp and is ideal for rapid reeling.
2. **Double PVC Coated Fiberglass Blade** for ultimate tape protection.
3. **Double Throat Rollers** guide the blade return and prevent the tape from twisting.
4. **Crank Handle** is reinforced with metal to provide years of rugged use.
5. **Better Blade Axle** to reduce breakage due to weight of the tape if dropped.



MODEL	UPC 052837	LENGTH	UNITS	ZERO POINT	ATTACHMENT	BLADE*
OTR1850	000203	50 ft.	ft, in, 1/8	Hook End	Hook	F1
OTR1050	001408	50 ft.	ft, 1/10, 1/100	Hook End	Hook	F2
OTR181050	000807	50 ft.	ft, in, 1/8 & ft, 1/10, 1/100	Hook End	Double Hook	F1 & F14
OTR18M50	000500	50 ft./15m	ft, in, 1/8 & m, cm, 2mm	Hook End	Double Hook	F1 & F13
OTR10M50	001101	50 ft./15m	ft, 1/10, 1/100 & m, cm, 2mm	Hook End	Double Hook	F2 & F13
OTR18100	000210	100 ft.	ft, in, 1/8	Hook End	Hook	F1
OTR10100	001415	100 ft.	ft, 1/10, 1/100	Hook End	Hook	F2
OTR1810100	000814	100 ft.	ft, in, 1/8 & ft, 1/10, 1/100	Hook End	Double Hook	F1 & F14
OTR18M100	000517	100 ft./30m	ft, in, 1/8 & m, cm, 2mm	Hook End	Double Hook	F1 & F13
OTR10M100	001118	100 ft./30m	ft, 1/10, 1/100 & m, cm, 2mm	Hook End	Double Hook	F2 & F13
OTR18165	000227	165 ft.	ft, in, 1/8	Hook End	Hook	F1
OTR10165	001422	165 ft.	ft, 1/10, 1/100	Hook End	Hook	F2
OTR18M165	000524	165 ft./50m	ft, in, 1/8 & m, cm, 2mm	Hook End	Double Hook	F1 & F13
OTR18200	000234	200 ft.	ft, in, 1/8	Hook End	Hook	F1
OTR10200	001439	200 ft.	ft, 1/10, 1/100	Hook End	Hook	F2
OTR1810200	000838	200 ft.	ft, in, 1/8 & ft, 1/10, 1/100	Hook End	Double Hook	F1 & F14
OTR18M200	000531	200 ft./60m	ft, in, 1/8 & m, cm, 2mm	Hook End	Double Hook	F1 & F13
OTR10M200	001132	200 ft./60m	ft, 1/10, 1/100 & m, cm, 2mm	Hook End	Double Hook	F2 & F13
OTR18300	000241	300 ft.	ft, in, 1/8	Hook End	Hook	F1
OTR10300	001446	300 ft.	ft, 1/10, 1/100	Hook End	Hook	F2
OTR1810300	000845	300 ft.	ft, in, 1/8 & ft, 1/10, 1/100	Hook End	Double Hook	F1 & F14
OTR18M300	000548	300 ft./100m	ft, in, 1/8 & m, cm, 2mm	Hook End	Double Hook	F1 & F13
OTR10M300	001149	300 ft./100m	ft, 1/10, 1/100 & m, cm, 2mm	Hook End	Double Hook	F2 & F13
OTR15M	001040	15m	m, cm, 2mm	Hook End	Hook	F3
OTR30M	010417	30m	m, cm, 2mm	Hook End	Hook	F3
OTR30MM	010455	30m	m, cm, 5mm & m, cm, 2mm	Hook End	Double Hook	F12 & F13
OTR50M	010424	50m	m, cm, 2mm	Hook End	Hook	F3
OTR50MM	010462	50m	m, cm, 5mm & m, cm, 2mm	Hook End	Double Hook	F12 & F13
OTR100M	010431	100m	m, cm, 2mm	Hook End	Hook	F3
OTR100MM	020027	100m	m, cm, 5mm & m, cm, 2mm	Hook End	Double Hook	F12 & F13

See Page 69

Limited lifetime warranty.

MC SERIES

MC SERIES | 10 SKUs, 2 LENGTHS

METAL CASE BLADE

We know that blade protection is key to a long tape life. Our metal case (MC) keeps the blades safe. These long, fiberglass tapes have a compact, closed metal case that fits nicely in your hand. The flush-folding crank pops up for easy rewinding. If you're measuring alone, the metal catch hook is set at zero, so there's no need for a correction. These are very popular with users that primarily do interior measurements.

FEATURES

1. **Metal Crank Handle** to provide years of rugged use.
2. **Heavy-Duty 1/2-Inch Blades** with 40,000 strands of fiberglass ensures a long life under the most demanding field use.
3. **Double-Throat Rollers** guide the blade return and prevent the tape from twisting.
4. **Closed, Metal Housing** protects the tape.

"This is it! If you work with a tape measure every day, this is the tape. It's accurate and reliable. I have been working with one for the past 12 years."

—Appraiser, Scott



⚠ WARNING!

This product can expose you to chemicals including LEAD which is known to the State of California to cause cancer or birth defects or reproductive harm. For more information, visit www.p65Warnings.ca.gov.

MODEL	UPC 052837	LENGTH	UNITS	ZERO POINT	ATTACHMENT	BLADE*
MC1850	000104	50 ft.	ft, in, 1/8	Hook End	Hook	F31
MC1050	001309	50 ft.	ft, 1/10, 1/100	Hook End	Hook	F32
MC181050	000708	50 ft.	ft, in, 1/8 & ft, 1/10, 1/100	Hook End	Double Hook	F31 & F44
MC18M50	000401	50 ft./15m	ft, in, 1/8 & m, cm, 2mm	Hook End	Double Hook	F31 & F43
MC10M50	001002	50 ft./15m	ft, 1/10, 1/100 & m, cm, 2mm	Hook End	Double Hook	F32 & F43
MC18100	000111	100 ft.	ft, in, 1/8	Hook End	Hook	F31
MC10100	001316	100 ft.	ft, 1/10, 1/100	Hook End	Hook	F32
MC1810100	000715	100 ft.	ft, in, 1/8 & ft, 1/10, 1/100	Hook End	Double Hook	F31 & F44
MC18M100	000418	100 ft./30m	ft, in, 1/8 & m, cm, 2mm	Hook End	Double Hook	F31 & F43
MC10M100	001019	100 ft./30m	ft, 1/10, 1/100 & m, cm, 2mm	Hook End	Double Hook	F32 & F43

See Page 69

Limited lifetime warranty.



PROFESSIONAL

Professional series tape measures offer a nylon coated blade in a high-impact, high-visibility housing. Full rubber grip for a comfortable and slip-resistant hold. Available in lengths up to 35-feet and 6 different units of measure available!



TOGGLE SERIES

Toggle locking, brightly colored case is our second most numerous offering.

Fractional Decimal Tapes:
our specialty tapes that break inches into decimals on one edge and fractions along the other.



ULTRA BRIGHT BLADE

Ultra Bright blade tapes are easy to read even in low light environments, and feature large print and high-contrast numbers. Double-sided blade offers vertical reading.

AUTOMATIC LOCK

The blade lock automatically engages. Our second most popular tape retracts with the push of the button.



WIDE BLADE

Our redesigned wide blade tapes feature a 1-3/16 inch blade with bigger numbers and a standout up to 10 feet.



MAGNETIC TIP

NEW, strong magnetic hook end sticks to any metal surface, enabling up to 10 feet of tape extension.



ECONOMY SERIES

A good tape at a very reasonable price. Co-molded plastic housing holds a lacquer-coated blade with easy-to-read markings and a side brake.



Measuring Wheels

Levels

Long Tapes

Short Tapes

Specialty Measures

Chalk & Chalk Line Reels

Specialty Marking

PROFESSIONAL

PGPRO | 17 SKUs, 10 LENGTHS

PGPRO_

Our Professional Series of tape measures has expanded. Tape housing is high-impact, high-visibility, Keson-Orange ABS. The entire family features stronger locks than our toggle series. They also offer our highest impact resistance and feature a slotted rubber grip for a comfortable and slip-resistant hold.

FEATURES

1. **Easy-Grip** rubber sleeve.
2. **Nylon-Coating** extends life of the blade.
3. **High-Impact, High Visibility, Keson-Orange ABS Case** with rubber grip protects the blade and stands up to heavy use.



A: 5/8-inch wide, nylon-coated, short tape



A1 = SAE: ft., in., 1/8, 1/16 (1/32 in. first ft.)



A4 = ENG/SAE: ft., 1/10, 1/100 & ft., in., 1/8, 1/16



A5 = SAE/M: ft., in., 1/8, 1/16 & cm, mm

B: 1-inch wide, nylon-coated, short tape



B1 = SAE: ft., in., 1/8, 1/16 (1/32 in. first ft.)



B2 = ENG: ft., 1/10, 1/100



B3 = METRIC: cm, mm



B4 = ENG/SAE: ft., 1/10, 1/100 & ft., in., 1/8, 1/16



B5 = SAE/M: ft., in., 1/8, 1/16 & cm, mm



B6 = ENG/M: ft., 1/10, 1/100 & cm, mm

PRODUCT FEATURES & BENEFITS

Lock	Slide					
Case	High visibility orange ABS				High visibility rubber grip	
Blade	Nylon-coated steel					
Impact Durability	High-visibility rubber grip				Holds up to accidental drops	
MODEL	UPC 052837	LENGTH	UNITS	WIDTH	STAND OUT	BLADE*
PGPRO3MV	029372	3m	m, cm, mm	16 mm	up to 8'	B3
PGPRO1810V	029327	10 ft.	ft, in, 1/8, 1/16 (1/32 first 12")	5/8"	up to 4'	A1
PGPRO18M10V	029303	10 ft./3m	ft, in, 1/8, 1/16 & cm, mm	5/8"	up to 4'	A5
PGPRO1812V	027873	12 ft.	ft, in, 1/8, 1/16 (1/32 first 12")	5/8"	up to 4'	A1
PGPRO181012V	029334	12 ft.	ft, 1/10, 1/100 & ft, in, 1/8, 1/16	5/8"	up to 4'	A4
PGPRO5MV	029389	5m	m, cm, mm	1"	up to 8'	B3
PGPRO1816V	027880	16 ft.	ft, in, 1/8, 1/16 (1/32 first 12")	1"	up to 8'	B1
PGPRO18M16V	029358	16 ft/5m	ft, in, 1/8, 1/16 & cm, mm	25 mm	up to 8'	B5
PGPRO1025V	029297	25 ft.	ft, 1/10, 1/100	1"	up to 8'	B2
PGPRO181025V	029310	25 ft.	ft, 1/10, 1/100 & ft, in, 1/8, 1/16	1"	up to 8'	B4
PGPRO1825V	027897	25 ft.	ft, in, 1/8, 1/16 (1/32 first 12")	1"	up to 8'	B1
PGPRO10M25V	029341	25 ft./7.5m	ft, 1/10, 1/100	1"	up to 8'	B6
PGPRO18M25V	029365	25 ft/7.5m	ft, in, 1/8, 1/16 & cm, mm	1"	up to 8'	B5
PGPRO8MV	029396	8m	m, cm, mm	25 mm	up to 8'	B3
PGPRO1830V	029426	30 ft.	ft, in, 1/8, 1/16 (1/32 first 12")	1"	up to 8'	B1
PGPRO181033V	029402	33 ft.	ft, 1/10, 1/100 & ft, in, 1/8, 1/16	1"	up to 8'	B4
PGPRO1835V	027903	35 ft.	ft, in, 1/8, 1/16 (1/32 first 12")	1"	up to 8'	B1

See Page 70

TOGGLE SERIES

PGT_V

This high-visibility, Keson-Orange series of tape measures features a toggle locking mechanism. The bright orange color makes these tapes easy to locate. This style remains a classic and is among our most popular. That is why we offer all of our unit options in this style. We even have 3 lengths (our FD sub-series) that break inches out in fractions on one edge of the blade and in decimals on the other edge (see blade B7).

FEATURES

1. **Nylon-Coating** extends life of the blade.
2. **High-Impact, High-Visibility, Keson-Orange ABS Case** protects the blade and stands up to heavy use.
3. **No Grip Case** design is simple to hold and slides easily in and out of any containers: tool bucket, bag, leather sheath, even pocket.



PGT1825V

PGT_V | 19 SKUs, 10 LENGTHS

A: 5/8-inch wide, nylon-coated, short tape

A1 = SAE: ft., in., 1/8, 1/16 (1/32 in. first ft.)

B2 = ENG: ft., 1/10, 1/100

A5 = SAE/M: ft., in., 1/8, 1/16 & cm, mm

A20 = M: cm, mm

B: 1-inch wide, nylon-coated, short tape

B1 = SAE: ft., in., 1/8, 1/16 (1/32 in. first ft.)

B2 = ENG: ft., 1/10, 1/100

B3 = METRIC: cm, mm

B4 = ENG/SAE: ft., 1/10, 1/100 & ft., in., 1/8, 1/16

B5 = SAE/M: ft., in., 1/8, 1/16 & cm, mm

A7 & B7 = Vertical Reading SAE/Dec: ft., in., 1/8, 1/16 & .125, .250, .375, etc.

A7 & B7 = Vertical Reading SAE/Dec: ft., in., 1/8, 1/16 & .125, .250, .375, etc.

PRODUCT FEATURES & BENEFITS

MODEL	UPC 052837	LENGTH	UNITS	WIDTH (IN)	STAND OUT (FT)	BLADE*
PGT1810V	027941	10 ft.	ft, in, 1/8, 1/16 (1/32 first 12")	5/8"	up to 5'	A1
PGT18M10V	028009	10 ft./3m	ft, in, 1/8, 1/16 & cm, mm	5/8"	up to 5'	A5
PGT1812V	027958	12 ft.	ft, in, 1/8, 1/16 (1/32 first 12")	5/8"	up to 5'	A1
PGT181012V	027910	12 ft.	ft, 1/10, 1/100 & ft, in, 1/8, 1/16	5/8"	up to 5'	A4
PGT1816V	027965	16 ft.	ft, in, 1/8, 1/16 (1/32 first 12")	1"	up to 8'	B1
PGT18M16V	028016	16 ft./5m	ft, in, 1/8, 1/16 & cm, mm	1"	up to 8'	B5
PGT1825V	027972	25 ft.	ft, in, 1/8, 1/16 (1/32 first 12")	1"	up to 8'	B1
PGT181025V	027927	25 ft.	ft, 1/10, 1/100 & ft, in, 1/8, 1/16	1"	up to 8'	B4
PGT18M25V	028023	26 ft./8m	ft, in, 1/8, 1/16 & cm, mm	1"	up to 8'	B5
PGT1830V	027989	30 ft.	ft, in, 1/8, 1/16 (1/32 first 12")	1"	up to 8'	B1
PGT181033V	027934	33 ft.	ft, 1/10, 1/100 & ft, in, 1/8, 1/16	1"	up to 8'	B4
PGT1033V	028375	33 ft.	ft, 1/10, 1/100	1"	up to 8'	B2
PGT1833V	027996	33 ft.	ft, in, 1/8, 1/16 (1/32 first 12")	1"	up to 8'	B1
PGTFD12V	028030	12 ft.	Vertical Reading Fractional (ft, in, 1/8, 1/16) & Decimal (.125, .250, .375, etc.)	5/8"	up to 5'	A7
PGTFD16V	028047	16 ft.	Vertical Reading Fractional (ft, in, 1/8, 1/16) & Decimal (.125, .250, .375, etc.)	1"	up to 8'	B7
PGTFD25V	028054	25 ft.	Vertical Reading Fractional (ft, in, 1/8, 1/16) & Decimal (.125, .250, .375, etc.)	1"	up to 8'	B7
PGT3MV	028269	3 m	m, cm, mm	16mm	up to 8'	A20
PGT5MV	028276	5 m	m, cm, mm	25mm	up to 8'	B3
PGT8MV	028283	8 m	m, cm, mm	25mm	up to 8'	B3

See Page 70

Measuring Wheels

Levels

Long Tapes

Short Tapes

Specialty Measures

Chalk & Chalk Line Reels

Specialty Marking



ULTRA BRIGHT BLADE

PG_UB | 6 SKUs, 4 LENGTHS

PG_UB

Our Ultra Bright class of short tape measures are easy to read in low light environments, and stay visually cleaner than black and white blades. Great for in-shadow measurements, for instance, those in cabinets and in corners. Also helpful in the meager light of dawn and of dusk. We've increased the number size to make them easier to read in any condition. We also have added a vertical reading feet and inches scale on the reverse side for vertical measurements.

We placed these high-contrast, large-numbered, blades in a solid-ABS housing that is further protected by rubber casing.

FEATURES

1. **Ultra Bright Blades** are easier to read in low light.
2. **Vertical Scale on the Reverse** makes it easier to measure vertical surfaces.
3. **Highly Visible Housing** makes it easy to find.

B: 1-inch wide, nylon-coated, short tape



B31 = SAE: ft., in., 1/8, 1/16



B34 = ENG/SAE: ft., 1/10, 1/100, & ft., in., 1/8, 1/16 (1/32 in. first ft.)



B35 = SAE/M: ft., in., 1/8, 1/16 & cm, mm



B22 = an easy-to-read SAE vertical blade (on all Ultra Bright Blades).



PG1825UB

PRODUCT FEATURES & BENEFITS

Blade Special	Ultra Bright Blade coloring with larger numbers	You can read the blade more easily in low light applications				
Blade Return	Impact Absorbing Bumper	Helps protect the end hook on tape return.				
Lock	Slide					
Case	High-Impact black ABS, high-visibility rubber grip	Quality case, easy to spot if dropped				
Blade	Nylon-coated steel					
Impact Durability	High-visibility rubber grip	Holds up to accidental drops				
MODEL	UPC 052837	LENGTH	UNITS	WIDTH (IN)	STAND OUT (FT)	BLADE*
PG1816UB	028306	16 ft.	ft, in, 1/8, 1/16	1"	up to 8'	B31 & B22
PG1825UB	028313	25 ft.	ft, in, 1/8, 1/16	1"	up to 8'	B31 & B22
PG181025UB	028337	25 ft.	ft, in, 1/10, 1/100 & ft, in, 1/8, 1/16	1"	up to 8'	B34 & B22
PG18M25UB	028320	25 ft./7.5m	ft, in, 1/8, 1/16 & cm, mm	1"	up to 8'	B35 & B22
PG1830UB	028344	30 ft.	ft, in, 1/8, 1/16	1"	up to 8'	B31 & B22
PG181033UB	028351	33 ft.	ft, in, 1/10, 1/100 & ft, in, 1/8, 1/16	1"	up to 8'	B34 & B22

See Page 71

WIDE BLADE

PG_WIDEV

Our Wide Blade tapes feature 1 3/16-inch blades. We also printed them with larger numbers so they are easier to read. As with all Wide Blade tapes, they have a longer stand out than a standard 1-inch tape. We also have users who insist that when running ours up a wall (with the attachment on the floor), they travel higher than other wide tapes before falling away.

FEATURES

1. **Stand out up to 10'** makes it easier for one person to get the job done.
2. **Nylon-Coating** extends life of the blade.
3. **High-Impact, High-Visibility, Keson-Orange ABS Case** with rubber grip protects the blade and stands up to heavy use.



PG1825WIDEV

PG_WIDEV | 6 SKUs, 4 LENGTHS

C: 1-3/16-inch wide, nylon-coated, short tape



C1 = SAE: ft., in., 1/8, 1/16 (1/32 in. first ft.)



C4 = ENG/SAE: ft., 1/10, 1/100, & ft., in., 1/8, 1/16 (1/32 in. first ft.)



C5 = SAE/M: ft., in., 1/8, 1/16 & cm, mm

Measuring Wheels

Levels

Long Tapes

Short Tapes

Specialty Measures

Chalk & Chalk Line Reels

Specialty Marking

PRODUCT FEATURES & BENEFITS

Lock	Slide					
Case	High-visibility and black ABS				High-visibility rubber grip	
Blade	Wide Blade, Nylon-coated steel					
Impact Durability	High-visibility rubber grip				Holds up to accidental drops	
MODEL	UPC 052837	LENGTH	UNITS	WIDTH (IN)	STAND OUT (FT)	BLADE*
PG1825WIDEV	027835	25 ft.	ft, in, 1/8, 1/16 (1/32 first 12")	1-3/16"	up to 10'	C1
PG181025WIDEV	027781	25 ft.	ft, in, 1/10, 1/100 & ft, in, 1/8, 1/16	1-3/16"	up to 10'	C4
PG18M25WIDEV	028436	25 ft./7.5m	ft, in, 1/8, 1/16 & cm, mm	1-3/16"	up to 10'	C5
PG1830WIDEV	028399	30 ft.	ft, in, 1/8, 1/16 (1/32 first 12")	1-3/16"	up to 10'	C1
PG181033WIDEV	028443	33 ft.	ft, in, 1/10, 1/100 & ft, in, 1/8, 1/16	1-3/16"	up to 10'	C4
PG1835WIDEV	028405	35 ft.	ft, in, 1/8, 1/16 (1/32 first 12")	1-3/16"	up to 10'	C1

See Page 72

AUTOMATIC LOCK

PG_AL | 4 SKUs, 2 LENGTHS

PG_ALV

The Automatic Lock features blades that stay out without the user needing to engage a lock. A push button releases the blade and enables it to retract. These tapes come with a rubber grip and are in a compact housing. They are available in a chrome coated or a high-visibility orange ABS case.

FEATURES

1. **Automatic Locking Blades** stay out without engaging a lock.
2. **Nylon-Coating** extends life of the blade.
3. **Stainless Steel or High-Impact, High Visibility, Keson-Orange ABS Case** with rubber grip protects the blade and stands up to heavy use.



PG1825ALV

B: 1-inch wide, nylon-coated, short tape



B1 = SAE: ft., in., 1/8, 1/16 (1/32 in. first ft.)



B4 = ENG/SAE: ft., 1/10, 1/100 & ft., in., 1/8, 1/16



B5 = SAE/M: ft., in., 1/8, 1/16 & cm, mm



B9 = SAE: ft., in., 1/8, 1/16 (1/32 in. first ft.) with Magnetic Tip



B9 = SAE: ft., in., 1/8, 1/16 (1/32 in. first ft.)



B10 = SAE/M: ft., in., 1/8, 1/16 & cm, mm

PRODUCT FEATURES & BENEFITS

Lock	Automatic, button-release					
Case	Chrome-coated ABS/ High-visibility orange ABS		Rubber grip/High visibility			
Blade	Nylon-coated steel					
Impact Durability	High-visibility rubber grip		Holds up to accidental drops			
MODEL	UPC 052837	LENGTH	UNITS	WIDTH (IN)	STAND OUT (FT)	BLADE*
PG1816ALVMAG	028702	16 ft.	ft, in, 1/8, 1/16 (1/32 first 12")	1"	up to 8'	B9
PG1825ALV	027804	25 ft.	ft, in, 1/8, 1/16 (1/32 first 12")	1"	up to 8'	B1
PG181025ALV	029433	25 ft.	ft, 1/10, 1/100 & ft, in, 1/8, 1/16	1"	up to 8'	B4
PG18M25ALV	029419	25 ft./7.5m	ft, in, 1/8, 1/16 & cm, mm	1"	up to 8'	B5

See Pages 70-71

MAGNETIC TIP

PG_VMAG | 3 SKUs, 3 LENGTHS

PG_VMAG

The magnetic hook end sticks to attach to any metal surface. Stick it to a metal door frame and you can pace off 10 feet or more. Great for drop ceiling work, steel framing, HVAC, and shop work.

A: 5/8-inch wide, nylon-coated, short tape



A9 = SAE: ft., in., 1/8, 1/16 (1/32 in. first ft.)

FEATURES

1. **Magnetic Tip** holds fast to metal attachment points.
2. **Nylon-Coating** extends life of the blade.
3. **High-Impact, High Visibility, Keson-Orange ABS Case** with rubber grip protects the blade and stands up to heavy use.



PG18M26VMAG

PRODUCT FEATURES & BENEFITS

Lock	Slide or Button release					
Case	Chrome-coated ABS/High visibility orange ABS		Rubber grip/High visibility			
Blade	Magnetic Tip, Nylon-coated steel					
Impact Durability	High-visibility rubber grip		Holds up to accidental drops			
MODEL	UPC 052837	LENGTH	UNITS	WIDTH (IN)	STAND OUT (FT)	BLADE*
PG1816ALVMAG	028702	16 ft.	ft, in, 1/8, 1/16 (1/32 first 12")	5/8"	up to 8'	A9
PG1825VMAG	027828	25 ft.	ft, in, 1/8, 1/16 (1/32 first 12")	1"	up to 8'	B9
PG18M26VMAG	028726	26 ft./8m	ft, in, 1/8, 1/16 & cm, mm	1"	up to 8'	B10

See Pages 70-71

ECONOMY SERIES

PG_ | 2 SKUs, 1 LENGTH

PG_

The co-molded plastic housing holds a lacquer-coated blade with easy to read marking of each eighth, quarter and half inch. A side brake will slow or stop the blade return when engaged. A good tape at a very reasonable price.

B: 1-inch wide, lacquer-coated, short tape



B2 = ENG: ft., 1/10, 1/100



B8 = SAE, ft., in., 1/8, 1/16 with fractions

FEATURES

1. **Side Brake** slows or stops the blade return when engaged.
2. **Lacquer Coated** blade.
3. **High-Impact, High-Visibility, ABS Case** with rubber grip protects the blade and stands up to heavy use.



PG25

PRODUCT FEATURES & BENEFITS

Lock	Slide					
Case	High-impact, high-visibility ABS with rubber grip					
MODEL	UPC 052837	LENGTH	UNITS	WIDTH (IN)	STAND OUT (FT)	BLADE*
PG25	022076	25 ft.	ft, in, 1/8, 1/16 with fractions	1"	up to 8'	B8
PG2510	026371	25 ft.	ft, 1/10, 1/100	1"	up to 8'	B2

See Pages 70-71

Measuring Wheels

Levels

Long Tapes

Short Tapes

Specialty Measures

Chalk & Chalk Line Reels

Specialty Marking

POCKET TAPES / DIAMETER TAPES



WOOD RULERS



DEPTH GAUGES / SURVEYOR'S ROPE



POCKET TAPE MEASURES

These small tapes are perfect for carrying in a pocket. The unique arch design of the PG1812SQ enables the tape to slip in and out without catching. It comes with a removable belt clip. The PG1810 has a magnetic back so it can stick to a file cabinet, cubical frame, door frame, or refrigerator.



PG10



PG1812SQ

MODEL	UPC 052837	LENGTH	WDTH	UNITS	CASE TYPE	BLADE MATERIAL	BLADE*
PG10	027596	10 ft.	1/4 in.	ft., in., 1/8, 1/16, 1/4	magnetic back	steel	
PG1812SQ	027798	12 ft.	5/8 in.	ft., in., 1/8, 1/16, (1/32 first 12")	special	steel	A1

Limited warranty.

KESON KEYCHAIN

Keychain tape measure available in both Feet & Inches as well as Metric measurements. Countertop display box is available.



PG18M6KC



PG186KC

MODEL	UPC 052837	LENGTH	UNITS
PG186KC	028719	6 ft.	ft, in, & 1/8,
PG18M6KC	027712	6 ft.	m. cm, mm

DIAMETER TAPES

The diameter of a circular object, like a tree or a pipe, is easily measured using a Keson diameter tape. The tape is calibrated in units of 3.14(pi) inches. The tape is actually measuring the tree or pipe's circumference, but the units on the tape are adjusted by pi enabling you to get a diameter by wrapping this tape around a circular object.

Our PD618 has a stainless steel case which features a reflective surface and textured rubber grip to keep the tape from slipping.



PD618



D18646

MODEL	UPC 052837	LENGTH	WIDTH	UNITS	CASE TYPE	BLADE MATERIAL	BLADE*
D18646	005703	6 ft.	1/4 in.	ft, in, (1/64 first 12") One side: diameter inches to 64ths Other side: blank space before zero	white ABS	steel	D2, D12
PD618	027750	6 ft.	1/4 in.	Side 1 (Top): inches in pi to the 100ths Side 2 (Bottom): continuous ft, in, 1/8/, 1/16	steel	steel	D1, D11

Limited warranty.

POCKET RODS

This 6-1/2 foot vertical-reading leveling rod or grading rod is packed in a compact like a tape measure. It's ideal for checking a grade without having to carry a full-size rod. Great for foundation work, grading, swimming pools and construction photo records. Easy-to-read numbers are printed on both sides.

FEATURES

- Built-in target on 2 sides.
- Nylon coated facing not affected by moisture.
- Non-glare surface.
- Convenient surveyors pole.
- Heavy-duty end hook.

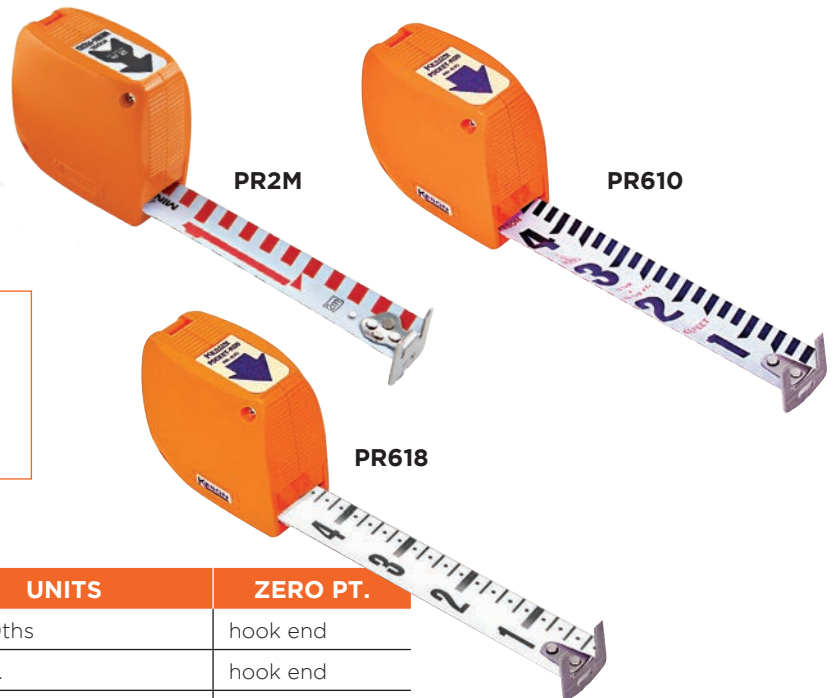

"Markings are clearly visible for photographing. I use it for appraisal work for damaged vehicles. No other product can be seen clearly in pictures while capturing the object behind it."

—Damage Appraiser, David

MODEL	UPC 052837	LENGTH	UNITS	ZERO PT.
PR610	005208	6.5 ft.	ft. & 10ths	hook end
PR618	005307	6.5 ft.	ft. & in.	hook end
PR2M	020416	2 m	metric	hook end

Limited warranty.

BRASS EXTENDER

The brass extender makes measuring tight openings a snap. Extends up to 6 inches, and sliding rule stops at each end to resist falling out. A very useful tool for carpenters.

FEATURES

1. Six-inch brass extender allows for accurate measuring in tight places.
2. Measures in feet and inches.
3. 1/16-inch graduations.

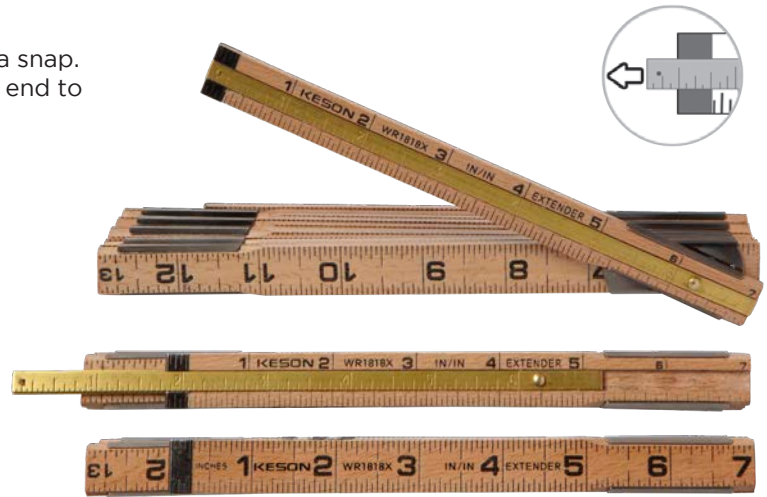

WR1818X

Measuring Wheels

Levels

Long Tapes

Short Tapes

Specialty Measures

Chalk & Chalk Line Reels

Specialty Marking



WR1818

INSIDE READ

This wood ruler has inside marking. Numeration starts on the inside of the rule, so the measurement lies close to the work.

FEATURES

1. Measurements are marked on both sides, both edges, graduated to 1/16-inch.
2. Measures in feet and inches.
3. Designed for carpentry and wood-working.

ENGINEER'S

Designed for engineer or other measurements requiring tenths and feet. Decimal points on engineer's scale prevent reading errors.

FEATURES

1. Graduated in feet, 10ths and 100ths.
2. Regular outside marking in feet, inches, graduated to 1/16-inch.
3. Engineer's side has foot marks in red, and decimal points.

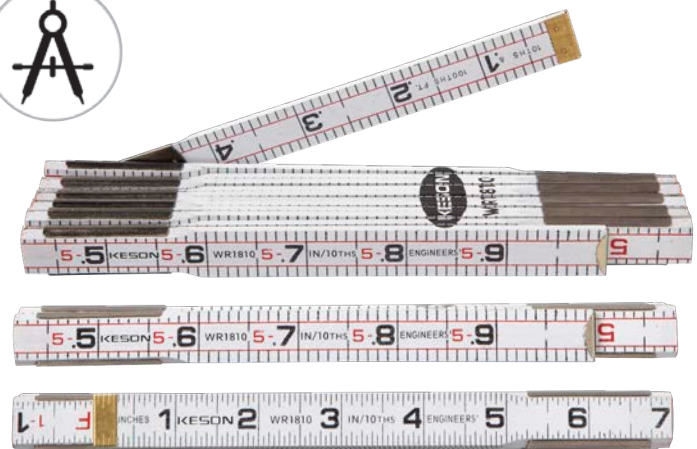

WR1810

METRIC

This 2-meter folding ruler measures in mm, cm, and meter graduations.

FEATURES

1. Measures in mm, cm, m & feet and inches.
2. 2 meter total length.
3. Metric measurements on one side, feet and inches on the other.



WR18M



WR18BL

BRICK MASON

Designed for use in bricklaying and mason's work, with a brick mason's scale on the inside.

FEATURES

1. Vertical Brick Mason scale on the inside rule.
2. Measures in feet and inches, graduated to 1/16-inch.
3. High-quality materials, clear protective coating.

MODEL	UPC 052837	LENGTH	UNITS	WIDTH (IN)	MATERIAL	SPECIAL
WR1818X	028511	6 ft.	ft, in & ft, in, with 6 in extender	5/8	Beechwood	Brass Extender
WR1818	028528	6 ft.	ft, in, 1/8, 1/16	5/8	Beechwood	Inside Read
WR1810	028535	6 ft.	ft, in, 1/8, 1/16 & ft, 1/10, 1/100	5/8	Beechwood	Engineer's
WR18M	028559	6.5 ft./2m	ft, in, 1/8, 1/16 & m, cm, mm	5/8	Beechwood	Metric
WR18BL	028542	6 ft.	ft, in & brick mason units	5/8	Beechwood	Brick Mason

SURVEYOR'S ROPE

Makes an ideal drag chain for rough surveying measurements. Numbers are graduated from the strap handle upward to the end of the rope.

FEATURES

- Tough, flexible and lightweight.
- White with black and red markings.
- Coating: Clear Coat.
- Tensile Strength: 100kg / 200 lbs.



SR18300

MODEL	UPC 052837	LENGTH	WIDTH	UNITS	BLADE MATERIAL
SR18100	005505	100 ft.	1/4 in.	ft. & in.	fiberglass
SR10100	005604	100 ft.	1/4 in.	ft. & 10ths	fiberglass
SR18200	005512	200 ft.	1/4 in.	ft. & in.	fiberglass
SR10200	005611	200 ft.	1/4 in.	ft. & 10ths	fiberglass
SR18300	005529	300 ft.	1/4 in.	ft. & in.	fiberglass
SR10300	005628	300 ft.	1/4 in.	ft. & 10ths	fiberglass
SR30M	021772	30 m	6.35mm	metric	fiberglass
SR50M	021789	50 m	6.35mm	metric	fiberglass
SR100M	021802	100 m	6.35mm	metric	fiberglass

Limited warranty.

DEPTH GAUGES

Developed for seismographic measuring, these tough fiberglass tapes are used by a variety of industries to measure depth. Attach any weight to the snap ring and lower to measure depth. The depth gauges are incredibly durable, flexible and lightweight with graduations printed on both sides.

FEATURES

- Numbers are graduated from the weighted end of the tape strap.
- Tough, flexible, and lightweight with graduations printed on both sides.
- White with black and red markings.
- Coating: Clear Coat.
- Tensile Strength: 100kg / 200 lbs.



DG20018

MODEL	UPC 052837	LENGTH	WIDTH	UNITS	BLADE MATERIAL
DG2518	025931	25 ft.	1/4 in.	ft. & in.	fiberglass
DG5018	005406	50 ft.	1/4 in.	ft. & in.	fiberglass
DG10018	005413	100 ft.	1/4 in.	ft. & in.	fiberglass
DG20018	005420	200 ft.	1/4 in.	ft. & in.	fiberglass
DG30018	028184	300 ft.	1/4 in.	ft. & in.	fiberglass
DG15M	026081	15 m	6.35mm	m, dm, cm	fiberglass
DG30M	026098	30 m	6.35mm	m, dm, cm	fiberglass
DG50M	026104	50 m	6.35mm	m, dm, cm	fiberglass

Limited warranty.

⚠

WARNING!

Products on this page can expose you to chemicals including DI (2-ETHYLHEXYL) PHTHALATE which is known to the State of California to cause cancer or birth defects or reproductive harm. For more information, visit www.p65Warnings.ca.gov.

Measuring Wheels

Levels

Long Tapes

Short Tapes

Specialty Measures

Chalk & Chalk Line Reels

Specialty Marking



MARKING

CHALK LINE
REELS

CHALK

MASON TWINE

PAINT

SPECIALTY
MARKING

FLAGGING &
BARRICADE
TAPE

A LITTLE ABOUT CHALK LINE REELS

A chalk line is a very simple tool that performs an essential task: it provides a perfectly straight line that is temporary to almost permanent. The material cost to do this essential task is very reasonable. In fact, once you own the reel, it's almost free.

At Keson, we've taken the time to learn a lot about chalk line reels from end-users. We are in a unique position to interact and respond with the people who build in and build up our communities. These builders have told us a lot about what's important in a chalk line reel, and what works and what doesn't. We continuously add to and improve our chalk and chalk line reels based on the feedback from end-users.

What's more, we offer suppliers complete and comprehensive Line Chalking Systems for your customers.

SIZE CLASS	STANDARD				GIANT		
SKU	K1	P100	K3X	K3XPro	G100, G110 G150BOLD	G3X G3X150BOLD	G130, G150
Chalk Fill Closure	Slide Door	Grommet	BigMouth*	BigMouth*	BigMouth*	BigMouth*	BigMouth*
Line Structure	Twisted	Braided	Twisted	Braided	Braided	Braided	Braided
Line Material	Poly	Poly	Poly	Poly	Poly or Cotton	Poly	Poly or Cotton
Line Thickness	Standard	Bold	Standard	Precision	Giant Bold	Giant Bold	Giant
Page No.	56	57	56	55	58 57	58 57	58

CAPACITY

The more chalk you can functionally put into a CLR, the more snaps you can get per fill up.

Standard: K1: 2 oz
P100, K3X, K3XPro: 3 to 3.5 oz

Giants: Little Giants: 12 - 16 oz
Giants: 24 - 27 oz

CHALK FILL CLOSURE

All Keson CLR's use a BigMouth® Grommet (except the K1). Two advantages of a grommet: openings are round, just like the openings for chalk bottles, and the grommet is an easy open and securely close system. Slide doors are rectangular, and can accidentally slide open.

Rectangle Slide: K1

Small BigMouth®: K3X, K3XPro

BigMouth®: G100, G110, G150BOLD, G3X, G3X150BOLD, G130, G150

GEAR RATIO

The higher the gear ratio, the faster you can reel in a chalk line. As chalk lines are pulled from the reel, and as they are retrieved, the string comes into contact with the chalk inside the reel. This is what coats it for the next strike. Go out or come in too fast, and you are missing the opportunity to fully coat your line. Also, bringing in a line too rapidly can cause jams and string twisting.

1X 100 feet in about 60 seconds

Rewind: 30 feet in about 15 seconds

3X 100 feet in about 25 seconds

Rewind: 30 feet in about 10 seconds

LINE STRUCTURE

How a string is put together determines how much chalk a line holds and how much chalk a line lays down. Strings of the same diameter and material perform differently based on their structure.

Twisted:

- Economical
- Picks up more chalk
- Puts down more chalk
- Stronger than braided

Braided:

- Uses less chalk
- Puts down less chalk with less ghosting

LINE MATERIAL











What a string is made of impacts how much chalk a line holds and how much chalk a line lays down. Strings of the same diameter and structure perform differently based on their material.

Natural (Cotton):

- Picks up more chalk
- Puts down more chalk
- Will mildew and weaken in damp environments

Synthetic (Poly):

- Picks up less chalk
- Puts down less chalk
- Lasts longer, stronger, more durable, and dampness does not affect

String Thickness	Precision <	Standard <	BOLD <	GIANT <
Width of snapped line	<0.99mm 	1.00-1.25mm 	1.26-2.00mm 	>2.00mm 
1X SKUS		 K1	 P100, G150BOLD	 G100, G110 G100C G130, G150 G150C
	 K3XPro	 K3X	 G3X150BOLD	 G3X
3X SKUS				

PRECISION LINES

Precision lines are more like a pencil trace than a traditional chalk line. This synthetic, braided line does not pick up a lot of chalk when exiting the reel. When it's snapped, there is not a lot of over spray or ghosting around the line.

**LINE THICKNESS:
PRECISION** <

PRECISION STRING

K3XPRO

FEATURES

1. **BigMouth®** chalk port for easy fill up and also ensures a protected seal.
2. **Flush handle and patented wedge shape** enables easy in and out of tool pouch.
3. **3X rewind with clutch release** for fast line pay out and retrieval.
4. **Metal rewind arm** and tough ABS and Aluminum case
5. **Oversize hook** holds true

APPLICATIONS

- Indoor work
- Fine woodworking
- Cabinetry
- Tile
- Mosaic work



K3XPRO

MODEL	UPC 052837	HOUSING	LENGTH	CAPACITY	SPECIAL
K3XPRO	028641	AL/ABS	100 ft	3-3.5 oz	3:1

Measuring Wheels

Levels

Long Tapes

Short Tapes

Specialty Measures

Chalk & Chalk Line Reels

Specialty Marking

STANDARD LINES

Standard lines are similar in size to a felt tip pen line. Our twisted synthetic line picks up and puts down more chalk than our precision line.

**LINE THICKNESS:
STANDARD**



STANDARD STRING



K3X

FEATURES

1. **BigMouth® chalk port** for easy fill up and also ensures a protected seal.
2. **Flush handle and patented wedge shape** enables easy in and out of tool pouch.
3. **3X rewind with clutch release** for fast line pay out and retrieval.
4. **Metal rewind arm** and tough ABS case.
5. **Molded and assembled in the USA.**

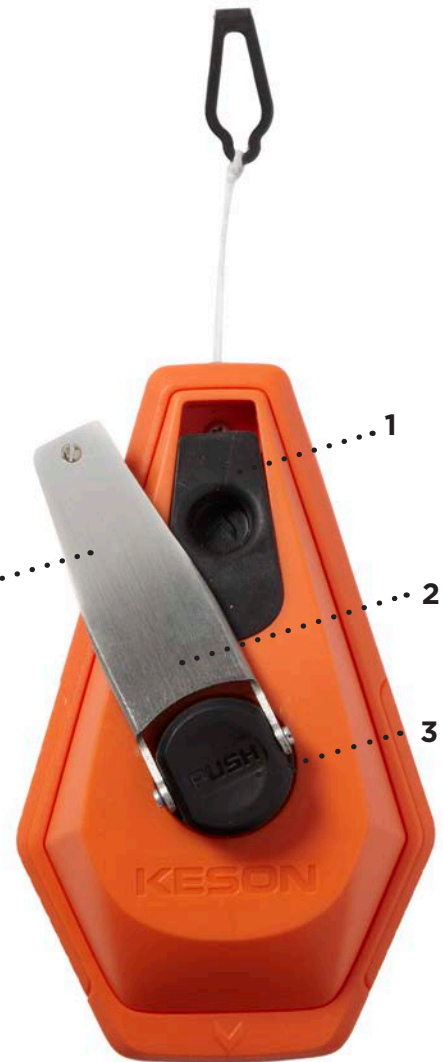

K3X

K1

FEATURES

1. **Compact and light** aluminum housing.
2. **Metal Rewind Arm.**
3. **Slide Door** for refills.



K1

MODEL	UPC 052837	HOUSING	LENGTH	CAPACITY	SPECIAL
K1	022656	AL	100 ft	2-3 oz	1:1
*K3X	028597	ABS	100 ft	3-3.5 oz	3:1

*Combo/Sets Available

BOLD LINES

Our bold string leaves lines a little larger than a felt-tip, but not quite a Sharpie. This string is more often used in higher traffic areas and outdoors.

LINE THICKNESS:
BOLD <



BOLD STRING



P100

FEATURES

1. **Unique shape** great for corner work.
2. **Heavy-duty steel crank** for long life.
3. **Holds 3 oz. of chalk**
4. **100 feet** bold string.



P100

G150BOLD

FEATURES

1. **Holds almost 1 pound of chalk** for fewer refills.
2. **BigMouth® chalk port** for easy fill up and a sure, protected seal.
3. **150 feet** bold string, and pull ring.
4. **One-piece steel crank handle** for long life.



G150BOLD

G3X150BOLD

FEATURES

1. **Ergonomic, glovable grip** designed to reduce wrist strain.
2. **12 ounce capacity**
3. **BigMouth® chalk port** for easy fill up and a sure, protected seal.
4. **3X rewind** for fast line pay out and retrieval.



G3X150BOLD

MODEL	UPC 052837	HOUSING	HANDLE	LENGTH	CAPACITY	SPECIAL
P100	023486	ABS	METAL	100 ft	3-3.5 oz	1:1
G150BOLD	028689	ABS	METAL	150 ft	12 oz	1:1
G3X150BOLD	028672	ABS	ABS	150 ft	12 oz	3:1

Measuring Wheels

Levels

Long Tapes

Short Tapes

Specialty Measures

Chalk & Chalk Line Reels

Specialty Marking

GIANT LINES

Our giant string leaves huge bold lines. Often used in parking lots, on streets, and on concrete, the Giant lines are easy to see.



G100

FEATURES

1. Holds almost 1 pound of chalk for fewer refills.
2. **BigMouth®** chalk port for easy fill up and a sure, protected seal.
3. 100 feet giant string, and pull ring.
4. One-piece steel crank for long life.



G150

FEATURES

1. Holds over 1 pound of chalk for fewer refills.
2. 150 feet giant string, and pull ring.
3. One-piece steel crank for long life.



G3X

FEATURES

1. Ergonomic, glovable grip designed to reduce wrist strain.
2. 12 ounce capacity
3. 3X rewind for fast line pay out and retrieval.



MODEL	UPC 052837	HOUSING	HANDLE	LENGTH	CAPACITY	SPECIAL
*G100	020089	ABS	Metal	100 ft	12 oz	1:1
G110	021895	ABS	Metal	110 ft	12 oz	1:1
G110D	023882	ABS	Metal	110 ft	12 oz X2	2 boxes
*G100C	026418	ABS	Metal	100 ft	12 oz	1:1 Cotton String
G130	005864	ABS	Metal	130 ft	24 oz	1:1
G150	021901	ABS	Metal	150 ft	24 oz	1:1
G150C	026777	ABS	Metal	150 ft	24 oz	1:1 Cotton String
G3X	028498	ABS	ABS	100 ft	12 oz	3:1
G3X100	026432	ABS	ABS	100 ft	12 oz	3:1 Chalk Catcher

*Combo/Sets Available

A LITTLE ABOUT PROCHALK®



ALL MARKING CHALK IS NOT CREATED EQUAL

Keson is the only company making marking chalk in the United States. We have formulated our colors to meet the diverse needs of our customers. The color and the amount of the pigment determines the vividness and permanence of the line. We believe we have created the best marking chalk in the world. It sticks to your line until you decide you want it to stick to something else. Over the years, we've fine-tuned our formulas to produce chalk that performs with consistent excellence, batch after batch.

FIVE LEVELS OF INTENSITY

We've engineered a range of colors with five variations of intensity.

ProChalk Standard for your basic chalk line needs that are easier to clean up or let wear away naturally.

ProChalk High Visibility which include our Glo-Orange, Glo-Lime and Yellow formulations for highly visible applications that will wear or wash away naturally in a few days.

ProChalk Semi-Permanent for weather- and water-resistant lines that hit and stick for a long time but will eventually wear away naturally.

ProChalk Permanent for weatherproof and waterproof lines that aren't going to go away any time soon. Most users are choosing this level of intensity for applications that are going to be covered. This level is engineered for more extreme conditions.

ProChalk Ultimate Dye which is almost 100% pigment for lines that are intended to be laid down once. Period.



⚠ WARNING!

This product (ProChalk) can expose you to chemicals including CRYSTALLINE SILICA and/or CARBON BLACK or FORMALDEHYDE which is known to the State of California to cause cancer or birth defects or reproductive harm. For more information, visit www.p65Warnings.ca.gov.

Permanency	Standard		High-Visibility			Semi-Permanent		Permanent			Ultimate Dye		
	Blue	White	Lime	Orange	Yellow	Black	Red	Black	Blue	Red	Black	Blue	Red
Permanence Rank	1		2			3		4			5		
Best for	Interior/Exterior		Exterior			Exterior		Exterior			Exterior		
Applications Include:	Interior Layout, Roofing, Siding, Paneling		Corrections, Plumbing, Electrical, Roofing, Masonry			Exterior Layout, Concrete Layout, Roofing, metal Fabrication		Exterior Layout, Concrete Layout, Extreme Conditions, Long-Term Applications			Exterior Layout, Concrete Layout, Extreme Conditions, Long-Term Applications		

PROCHALK® STANDARD

INTERIOR OR EXTERIOR USE

Applications include interior layout, as well as roofing, siding, and concrete. For interior or exterior use.

1 2 3 4 5
Performance Ranking

MODEL	UPC 052837	COLOR	WEIGHT	SPECIAL
8B	006120	blue	8 oz.	Best seller
8W	006113	white	8 oz.	
103B	020584	blue	3 lbs	
105B	006328	blue	5 lbs	
105W	006311	white	5 lbs.	
125B	006526	blue	25 lbs.	
125W	006519	white	25 lbs.	Best seller
148B	006625	blue	48 lbs.	
148W	006618	white	48 lbs.	Best seller



PROCHALK® HIGH VISIBILITY

STRIKE ONCE, STRIKE BOLD!

Exterior applications include plumbing, electrical, roofing, and masonry.

1 **2** 3 4 5
Performance Ranking

MODEL	UPC 052837	COLOR	WEIGHT	SPECIAL
8GL	006427	glo-lime	8 oz.	Glo-color
8GO	006403	glo-orange	8 oz.	Glo-color
8Y	006137	yellow	8 oz.	Glo-color
103GO	020591	glo-orange	3 lbs.	Glo-color
105GL	020188	glo-lime	5 lbs.	Glo-color
105GO	006410	glo-orange	5 lbs.	Glo-color
105Y	006335	yellow	5 lbs.	Glo-color
125GO	006540	glo-orange	25 lbs.	Glo-color
125Y	006533	yellow	25 lbs.	Glo-color
148GO	006649	glo-orange	48 lbs.	Glo-color
148Y	006632	yellow	48 lbs.	Glo-color



PROCHALK® SEMI-PERMANENT

MARKING CHALK WATERPROOF

Exterior applications include concrete layout, roofing, metal fabrication.

1 2 **3** 4 5
Performance Ranking

MODEL	UPC 052837	COLOR	WEIGHT	SPECIAL
8BLACK	025954	black	8 oz.	
8R	006106	red	8 oz.	
103BLACK	026203	black	3 lbs.	
103R	020577	red	3 lbs.	Best seller
105BLACK	026210	black	5 lbs.	
105R	006304	red	5 lbs.	Best seller
125R	006502	red	25 lbs.	
148R	006601	red	48 lbs.	



PROCHALK® PERMANENT

WEATHERPROOF MARKING CHALK

Exterior applications include exterior layout, extreme conditions, concrete layout, long-term applications.

1 2 3 **4** 5
Performance Ranking

MODEL	UPC 052837	COLOR	WEIGHT	SPECIAL
PM8BLACK	021482	black	8 oz.	Waterproof
PM8BLUE	021505	blue	8 oz.	Waterproof
PM8RED	021529	red	8 oz.	Waterproof
PM103BLACK	021499	black	3 lbs.	Waterproof
PM103BLUE	021512	blue	3 lbs.	Waterproof
PM103RED	021536	red	3 lbs.	Waterproof
PM105BLACK	025299	black	5 lbs.	Waterproof
PM105BLUE	025688	blue	5 lbs.	Waterproof
PM105RED	025695	red	5 lbs.	Waterproof

These are concentrated marking products. Lines snapped with ProChalk Semi-Permanent, Permanent, and Ultimate Dye grades may be visible as long as one year after striking. The colors also may bleed through light-colored paint.



Measuring Wheels

Levels

Long Tapes

Short Tapes

Specialty Measures

Chalk & Chalk Line Reels

Specialty Marking

PROCHALK[®] ULTIMATE DYE

WATERPROOF PERMANENT MARKING DYE

Exterior applications include concrete layout, exterior layout, extreme conditions, long-term applications.



1 2 3 4 **5**
Performance Ranking

MODEL	UPC 052837	COLOR	WEIGHT	SPECIAL
5BD	025916	blue	5 oz.	chalk-dye
5RD	026838	red	5 oz.	chalk-dye
5BLACKD	029136	black	5 oz.	chalk-dye
103BD	026036	blue	3 lbs.	chalk-dye
103RD	026856	red	3 lbs.	chalk-dye
103BLACKD	029143	black	3 lbs.	chalk-dye



Keson is proud to be a partner with TroopsDirect in its mission of helping American service members. We regularly donate pallets of glo orange and blue chalk to our troops in Afghanistan. Troops use the donation for marking and identifying IED lanes by temporarily discoloring their location with marking chalk, which allows troops and local residents to pass safely.

BRAIDED MASON TWINE

Braided twine doesn't come apart even when reused. It is perfect for large jobs and everyday use. You can also nick it with a trowel and it won't unwind. Another benefit is that braided twine does not spin as much as a twisted line, bringing plumb bobs to rest sooner.

FEATURES

- 18-gauge line with an approximate tensile strength of 155 pounds.
- 250 feet = 1/4 pound, 500 feet = 1/2 pound, 1,000 feet = 1 pound.



MODEL	UPC 052837	COLOR	LENGTH
BWB250	020478	black & white	250 ft.
BWB500	020485	black & white	500 ft.
BWB1000	020492	black & white	1000 ft.
GB250	008278	green	250 ft.
GB500	008285	green	500 ft.
GB1000	008292	green	1000 ft.
OB250	008216	orange	250 ft.
OB500	008223	orange	500 ft.
OB1000	008230	orange	1000 ft.

MODEL	UPC 052837	COLOR	LENGTH
PB250	008247	pink	250 ft.
PB500	008254	pink	500 ft.
PB1000	008261	pink	1000 ft.
WB250	108152	white	250 ft.
WB500	108169	white	500 ft.
WB1000	108176	white	1000 ft.
YB250	108183	yellow	250 ft.
YB500	008193	yellow	500 ft.
YB1000	008209	yellow	1000 ft.

TWISTED MASON TWINE

Twisted line is a fine choice for mason line and other marking needs. Choosing twisted line is often an economical choice. You get 10% more line per spool.

FEATURES

- 18-gauge line with an approximate tensile strength of 160 pounds.
- 275 feet = 1/4 pound, 545 feet = 1/2 pound, 1,090 feet = 1 pound



MODEL	UPC 052837	COLOR	LENGTH
GT275	108121	green	275 ft.
GT545	008131	green	545 ft.
GT1090	108145	green	1090 ft.
OT275	008063	orange	275 ft.
OT545	008070	orange	545 ft.
OT1090	008087	orange	1090 ft.
PT275	008094	pink	275 ft.
PT545	108107	pink	545 ft.
PT1090	008117	pink	1090 ft.

MODEL	UPC 052837	COLOR	LENGTH
WT275	008001	white	275 ft.
WT545	008018	white	545 ft.
WT1090	008025	white	1090 ft.
YT275	008032	yellow	275 ft.
YT545	008049	yellow	545 ft.
YT1090	008056	yellow	1090 ft.

Measuring Wheels

Levels

Long Tapes

Short Tapes

Specialty Measures

Chalk & Chalk Line Reels

Specialty Marking

ULTRA-MARK® PAINT

Formulated to generate superior brilliance for long-range visibility. Before marking a dark surface, spray a coat of white to enhance the brightness of the paint. The Ultra-Mark spray paint contains no fluorocarbons, making it non-toxic after drying. Top discharge valve for ease of use. All Keson paint is water based.

Use with **PA14**, **PA35**, **RRPA18** and **RRPA182** applicators (see page 17).

HOW MUCH IS ENOUGH?

A 16-ounce can provides approx. 250 feet of a 4-inch wide line. A 20-ounce can covers approx. 300 feet with the same 4-inch line.

How much Paint is in the can? Compare the Net Weights.

Federal law requires that the cans clearly label the net weight of paint.

20 ounce cans =

Keson: 17 oz. of paint + 3 oz. of propellant (for 16 oz. cans it's 14:2)

Most Competitors: 15 - 16 oz. of paint + 4 or 5 oz. of propellant for their 16 oz. cans it's 13:3)



100% of Keson paint is made in the USA. Shelf life of a can of paint is approximately 1 year.

APMA UNIFORM COLOR CODE		
	WHITE	Proposed Excavation
	PINK	Temporary Survey Markings
	RED	Electric Power Lines, Cables, Conduit & Lighting Cables
	YELLOW	Gas, Oil, Stream, Petroleum or Gaseous Materials
	ORANGE	Communication, Alarm or Signal Lines, Cables or Conduit
	BLUE	Potable Water
	GREEN	Sewers and Drain Lines

MODEL	UPC 052837	WEIGHT	COLOR
SP16RO	009015	16 oz.	red-orange
SP16W	009176	16 oz.	white
SP20B	009145	20 oz.	blue
SP20BK	021970	20 oz.	black
SP20G	009169	20 oz.	green
SP20GO	021963	20 oz.	glo-orange
SP20GP	009121	20 oz.	glo-pink
SP20R	009138	20 oz.	red
SP20RO	009114	20 oz.	red- orange
SP20W	021956	20 oz.	white
SP20Y	009152	20 oz.	yellow
CS16	020553	16 oz.	clear
CS20	009077	20 oz.	clear

PAINT APPLICATORS

Measure and mark simultaneously with RRPA18 and RRPA182. See full information on page 17.

CHALK LINE SAVER

Clear spray protects chalk line from wind, rain, and shuffling feet. Save hours of rework by protecting your layout!



WARNING!

This product (ULTRA-MARK PAINT) can expose you to chemicals including Ethylbenzene (100-41-4) which is known to the State of California to cause cancer and Toluene (108-88-3) (Chalk Line Saver) which is known to cause reproductive harm. For more information, visit www.p65Warnings.ca.gov.

VALVE PAINT MARKERS (PAINT PENS)

Marks on all surfaces: metal, wood, glass, plastic, rubber, cardboard and paper.



MODEL	UPC 052837	COLOR	TYPE
VPMB	023660	blue	Valve paint marker/paint pen
VPMBK	023677	black	
VPMR	023684	red	
VPMW	023653	white	
VPMY	023646	yellow	

HARD LUMBER CRAYONS AND HOLDERS

Ideal for warmer climates, and for marking on dry and wet wood, paper, cartons, stone, concrete, tiles, and plastic. Weather and wear resistant.



MODEL	UPC 052837	COLOR
LCBlack	009237	black
LCBlue	009220	blue
LCOrange	021314	orange
LCRed	009206	red
LCWhite	009213	white
LCYellow	009251	yellow
PS100	008124	

CARPENTER PENCILS

MODEL	UPC 052837	SPECIAL
LP72	007905	Black lead
LP72R	020560	Red lead
LP72WHITE	007736	White wood, black lead



CHINA MARKERS

MODEL	UPC 052837	COLOR	SPECIAL
* CMBBULK	023790	blue	Available only in bulk
* CMBKBULK	023806	black	



* While Supplies Last

SOAPSTONE

Keson soapstone is primarily used by welders for metal marking or by plumbers for pipe marking. Use Keson Chalk Line Saver (p. 43) to make the mark last.

MODEL	UPC 052837	COLOR	SPECIAL
SS144BULK	024230	white	Soapstone
SH500	024247	NA	Soapstone holder



Measuring Wheels
Levels
Long Tapes
Short Tapes
Specialty Measures
Chalk & Chalk Line Reels
Specialty Marking

BARRICADE TAPE

PROFESSIONAL - 3" WIDE

High-strength, high-visibility barricade tape is manufactured with a superior quality, virgin, yellow opaque poly-material. It is printed with ultra-bond, jet black ink that penetrates the plastic surface. It is scratch-proof and weather-resistant.



MODEL	UPC 052837	COLOR	LENGTH	LEGEND
BT1200E	026548	yellow	1,000 ft.	caution, caution, caution
BT1211	841749048508	yellow	1,000 ft.	caution: cuidado
BT1214	841749025028	red	1,000 ft.	danger, danger
BT300	841749052833	yellow	300 ft.	caution, caution, caution

REINFORCED BARRICADE TAPE

Heavy-Duty - 3" WIDE

Heavy-Duty, Reinforced Barricade Tape is a NON-ADHESIVE 7-mil thick reinforced tape used by professionals in safety, construction, painting, mining, hardware, utilities, and many other industries. It is a co-extruded polyethylene tape embedded with woven polyester fibers for added tensile strength.



MODEL	UPC 052837	COLOR	LENGTH	LEGEND
BT511	841749047921	yellow	500 ft.	caution, cuidado
BT514	841749025134	red	500 ft.	danger

FLAGGING TAPE

1-3/16" WIDE - Boxed

MODEL	UPC 052837	LENGTH	COLOR
FTGL	006823	150 ft.	glo-lime
FTGO	006809	150 ft.	glo-orange
FTGP	006830	150 ft.	glo-pink
FTGR	006816	150 ft.	glo-red
FTB	006731	300 ft.	blue
FTG	010646	300 ft.	green
FTO	006717	300 ft.	orange
FTP	010653	300 ft.	pink
FTR	006700	300 ft.	red
FTW	006748	300 ft.	white
FTY	006724	300 ft.	yellow



FLOURESCENT

WARNING! 

Products on this page can expose you to chemicals including DI(2-ETHYLHEXYL) PHTHALATE which is known to the State of California to cause cancer or birth defects or reproductive harm. For more information, visit www.p65Warnings.ca.gov.

FOIL UNDERGROUND DETECTABLE TAPE

PERMANENT MESSAGE

Color band and black ink imprint are encapsulated in the tape. Ink does not extend to edges, giving maximum bond between plies.

ALUMINUM CORE

A solid detectable core makes it the choice for locating nonmetallic lines.

DURABLE

Constructed with prime resin, it's durable. Tolerates -94° F to 200° F temperature range.

ENDORSED

Meets OSHA regulation 1926-956 (C) (I) covering location of underground utility lines.



MODEL	UPC 052837	COLOR	LENGTH	LEGEND	WIDTH
FDT2BEL	022939	red	1,000 ft.	electric line	2 in.
FDT2BFOL	023080	orange	1,000 ft.	fiber optic line	2 in.
FDT2BGL	022991	yellow	1,000 ft.	gas line	2 in.
FDT2BSL	023110	green	1,000 ft.	sewer line	2 in.
FDT2BWL	023059	blue	1,000 ft.	water line	2 in.
FDT3BEL	022946	red	1,000 ft.	electric line	3 in.
FDT3BFOL	023080	orange	1,000 ft.	fiber optic line	3 in.
FDT3BGL	023004	yellow	1,000 ft.	gas line	3 in.
FDT3BSL	023127	green	1,000 ft.	sewer line	3 in.
FDT3BWL	023066	blue	1,000 ft.	water line	3 in.
FDT6BEL	022953	red	1,000 ft.	electric line	6 in.

SURVEYOR STAKE FLAGS

2-1/2" x 3-1/2" FLAGS ON A 21" STAKE



MODEL	UPC 052837	COLOR	BUNDLE
STK21B	010288	blue	100
STK21G	010301	green	100
STK21GL	010264	glo-lime	100
STK21GO	010240	glo-orange	100
STK21GP	010271	glo-pink	100
STK21GR	010257	glo-red	100
STK21W	006977	white	100
STK21Y	010295	yellow	100

WARNING!

Products on this page can expose you to chemicals including DI(2-ETHYLHEXYL) PHTHALATE which is known to the State of California to cause cancer or birth defects or reproductive harm. For more information, visit www.p65Warnings.ca.gov.

Measuring Wheels
Levels
Long Tapes
Short Tapes
Specialty Measures
Chalk & Chalk Line Reels
Specialty Marking

E = 3/8-INCH WE, 2X NYLON COATED STEEL, LONG TAPE



E1 = Hook, Zero = Hook end, SAE: ft., in., 1/8



E2 = Ring, Zero = Tape end, ENG: ft., 1/10, 1/100



E3 = Hook, Zero = Hook end, Metric: cm, mm



E15 = Double Hook, Zero = Hook end, SAE (Black and Red)/Metric (Red): ft., in., 1/8 & cm, mm



E17 = Ring, Zero = Tape end + .3 meters, Metric: cm, mm



E19 = Ring, Zero = Tape end + 1 foot, ENG: ft., 1/10, 1/100



E22 = Hook, Zero = Hook end, ENG: ft., 1/10, 1/100



E23 = Ring, Zero = Tape end, Metric: cm, mm

G = 3/8-INCH, LACQUER-COATED STEEL, LONG TAPE



G1 = Hook, Zero = Hook end, SAE: ft., in., 1/8



G2 = Hook, Zero = Hook end, ENG: ft., 1/10, 1/100



G3 = Double Hook, Zero = Hook end, Metric: cm, mm

F = 1/2-INCH WIDE, FIBERGLASS, LONG TAPE



F1 = Hook, Zero = Hook end, SAE: ft., in., 1/8



F2 = Hook, Zero = Hook end, ENG: ft., 1/10, 1/100



F3 = Hook, Zero = Hook end, Metric: cm, 2mm



F12 = Hook, Zero = Hook end, Metric: cm, 5mm



F13 = Hook, Zero = Hook end, Metric (YELLOW): cm, 2mm



F14 = Hook, Zero = Hook end, ENG (YELLOW): ft., 1/10, 1/100



F20 (front view) = Ring, Zero = Tape end, SAE: ft., in., 1/8



F20 (back view) = Ring, Zero = Tape end, ENG (YELLOW): ft., 1/10, 1/100



F31 = Hook, Zero = Hook end, SAE: ft., in., 1/8



F32 = Hook, Zero = Hook end, ENG: ft., 1/10, 1/100



F43 = Hook, Zero = Hook end, Metric (YELLOW): cm, 2mm



F44 = Hook, Zero = Hook end, ENG (YELLOW): ft., 1/10, 1/100

A = 5/8-INCH WIDE, NYLON-COATED, SHORT TAPE

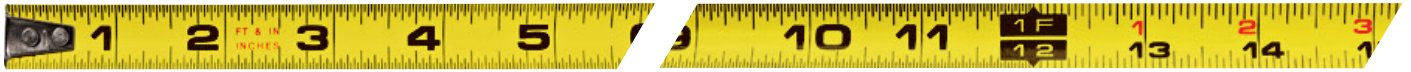

A1 = SAE: ft., in., 1/8, 1/16 (1/32 first ft.)

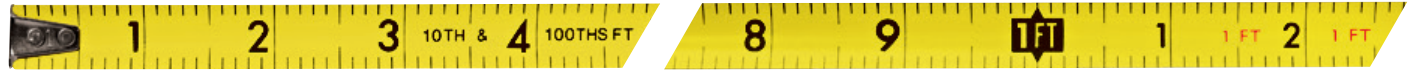

A2 = ENG: ft., 1/10, 1/100



A4 = ENG/SAE: ft., 1/10, 1/100 & ft., in., 1/8, 1/16



A5 = SAE/M: ft., in., 1/8, 1/16 & cm, mm



A7 = Vertical Reading Fractional (ft., in., 1/8, 1/16) & Decimal (.125, .250, .375, etc.)



A9 = SAE: ft., in., 1/8, 1/16 (1/32 first ft.)



A20 = Metric, m, cm, mm

B = 1-INCH WIDE, NYLON-COATED, SHORT TAPE



B1 = SAE: ft., in., 1/8, 1/16 (1/32 in. first ft.)



B2 = ENG: ft., 1/10, 1/100



B3 = Lacquer-coated, Metric: cm, mm



B4 = ENG/SAE: ft., 1/10, 1/100 & ft., in., 1/8, 1/16



B5 = SAE/M: ft., in., 1/8, 1/16 & cm, mm

B = 1-INCH WIDE, NYLON-COATED, SHORT TAPE (CON'T.)



B6 = ENG/M: ft., 1/10, 1/100 & cm, mm



B7 = Vertical Reading Fractional (ft., in., 1/8, 1/16) & Decimal (.125, .250, .375, etc.)



B8 = Lacquer-coated, SAE: ft., in., 1/8, 1/16 with fractions

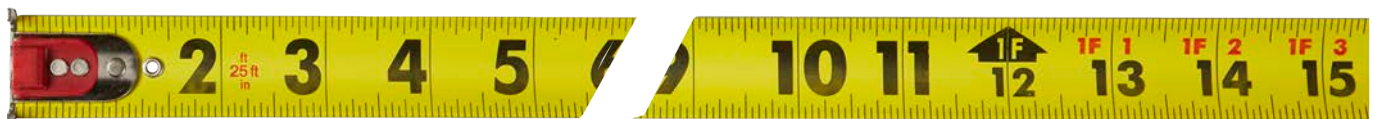

B9 = Magnet, SAE: ft., in., 1/8, 1/16 (1/32 in. first ft.)



B10 = Magnetic, SAE/M: ft., in., 1/8, 1/16 & cm, mm



B18 = Lacquer-coated, SAE, ft., in., 1/8, 1/16



B20 = Metric, m, cm, mm



B22 = Vertical Reading, SAE: ft., in., 1/8, 1/16 (1/32 in. first ft.)



B31 = Ultra Bright, SAE: ft., in., 1/8, 1/16



B34 = Ultra Bright, ENG/SAE: ft., 1/10, 1/100 & ft., in., 1/8, 1/16



B35 = Ultra Bright, SAE/m: ft., in., 1/8, 1/16 & cm, mm

C = 1-3/16 INCH WIDE, NYLON-COATED, SHORT TAPE

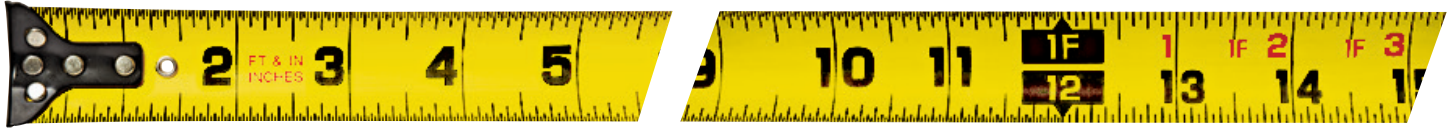

C1 = SAE: ft., in., 1/8, 1/16 (1/32 in. first ft.)



C4 = ENG/SAE: ft., 1/10, 1/100 & ft., in., 1/8, 1/16

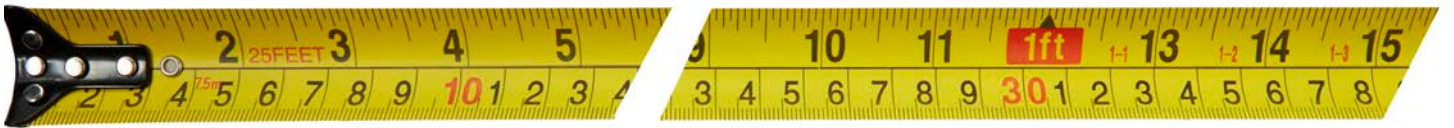

C5 = SAE/M: ft., in., 1/8, 1/16 & cm, mm

D = 1/4-INCH WIDE, LACQUER-COATED POCKET TAPE



D1 = SAE: ft., in., 1/8, 1/16



D11 = diameter inches to the 100th



D2 = SAE: ft, in., 1/8, 1/16



D12 = diameter inches to the 64th

103B 60	DG30M.....51	LCBLACK.....65	MP301DM11
103BD62	DG501851	LCBLUE65	MP301M.....11
103BLACK61	DG50M.....51	LCGORANGE65	MP315M.....12
103BLACKD62	FDT2BEL67	LCRED.....65	MP401.....11
103GO.....60	FDT2BFOL67	LCWHITE.....65	MP401E10
103R61	FDT2BGL67	LCYELLOW65	MP401P11
103RD62	FDT2BSL67	LKB24.....22	MP41512
105B60	FDT2BWL67	LKB24M.....23	MPLG CASE12
105BLACK61	FDT3BEL67	LKB32.....22	MPSM CASE.....10, 11, 12
105GL.....60	FDT3BFOL.....67	LKB32M.....23	NR1010031
105GO.....60	FDT3BGL.....67	LKB4822	NR10100H.....31
105R61	FDT3BSL67	LKB48M.....23	NR1020031
105W.....60	FDT3BWL67	LKB7222	NR10200H.....31
105Y60	FDT6BEL67	LKB72M23	NR1810031
125B.....60	FLT1016534	LKB78.....22	NR18165.....31
125GO60	FLT10200.....34	LKB7832.....22	NR1820031
125R.....61	FLT181020034	LKB7832M.....23	NR30MH.....31
125W60	FLT1816534	LKB78M23	NR60M.....31
125Y.....60	FLT1820034	LKB9622	NRS10100H.....30
148B60	FLT18M16534	LKB24D.....24	NRS10200H.....30
148GO.....60	FLT18M20034	LKB48D.....24	NRS10300H.....30
148R61	FLT50MM34	LKGOM.....27	NRS18100.....30
148W60	FTB.....66	LKI24.....25	NRS18200.....30
148Y.....60	FTG.....66	LKI4825	NRS18300.....30
5BD.....62	FTGL66	LKI72.....25	NRS18M100.....30
5BLACKD.....62	FTGO66	LKL3.....27	NRS18M200.....30
5RD.....62	FTGP66	LKS118.....26	NRS18M330.....30
8B.....60	FTGR.....66	LKS39.....26	OB100063
8BLACK.....61	FTO.....66	LKS59.....26	OB250.....63
8GL.....60	FTP66	LKS7826	OB50063
8GO60	FTR.....66	LKS78A.....26	OT1090.....63
8R.....61	FTW66	LKS7839.....26	OT275.....63
8W60	FTY.....66	LKS98.....26	OT545.....63
8Y60	G100.....58	LKTALRM.....27	OTR100M.....36
BT1200E.....66	G100C.....58	LKTFM.....27	OTR100MM.....36
BT1211.....66	G11058	LKTPRM.....27	OTR1010036
BT121466	G110D.....58	LKTRF27	OTR1020036
BT30066	G13058	LKTSF.....27	OTR1030036
BT51166	G15058	LP7265	OTR105036
BT514.....66	G150C.....58	LP72R65	OTR10M100.....36
BWB100063	G150BOLD.....57	LP72WHITE.....65	OTR10M200.....36
BWB25063	G3X.....58	MC10100.....37	OTR10M300.....36
BWB50063	G3X100.....58	MC1050.....37	OTR10M50.....36
CMBULK.....65	G3X150BOLD.....57	MC10M100.....37	OTR15M.....36
CMBKBULK.....65	GB1000.....63	MC10M50.....37	OTR18100.....36
CS1664	GB250.....63	MC18100.....37	OTR1810100.....36
CS2064	GB500.....63	MC1810100.....37	OTR1810200.....36
D18646.....48	GT109063	MC181050.....37	OTR1810300.....36
DG1001851	GT27563	MC1850.....37	OTR181050.....36
DG15M51	GT545.....63	MC18M100.....37	OTR18165.....36
DG2001851	K1.....56	MC18M50.....37	OTR18200.....36
DG2518.....51	K3X.....56	MP201.....12	OTR18300.....36
DG3001851	K3XPRO.....55	MP301.....11	OTR1850.....36

ENHANCE YOUR PRECISION

WORK WITH THE WORLD'S MOST ACCURATE BOX BEAM LEVELS

THE SPECIALIST IN MEASURING AND MARKING TOOLS FOR CONSTRUCTION

SOLA offers a wide range of premium-quality measuring and marking tools for construction professionals. With a product range of more than 1,500 items, we support craftsmen across the world in achieving their objectives with higher precision and productivity.



PATENTED FOCUS VIAL

- › Quicker and much easier to read
- › +60% magnification of bubble
- › 4x higher contrast over ring vials
- › No split bubble



HIGHEST PRECISION

- › Standard position:
 $\leq 0.0003 \text{ in./in. (} 0.017^\circ, 0.30 \text{ mm/m)}$
- › Inverted position:
 $\leq 0.0005 \text{ in./in. (} 0.029^\circ, 0.50 \text{ mm/m)}$

PREMIUM MEASURING AND MARKING TOOLS MADE IN AUSTRIA SINCE 1949



Box beam levels



Precision spirit levels



Short levels



Digital levels



Pencils



Deep hole markers



810 N. COMMERCE STREET
AURORA, ILLINOIS 60504

800.345.3766 • FAX: 800.345.8849 • WWW.KESON.COM • SALESORDERS@KESON.COM